

# Chapter 1. Disassembly & Assembly Guide

---

## 1-3. Disassembly & Assembly

### - Main Section -

#### MS-1 Main Section Disassembly

# Battery Pack

1)

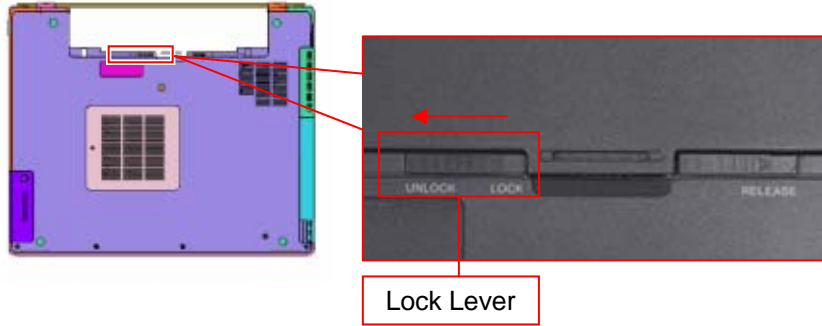

Slide the Lock Lever to the UNLOCK side.

2)

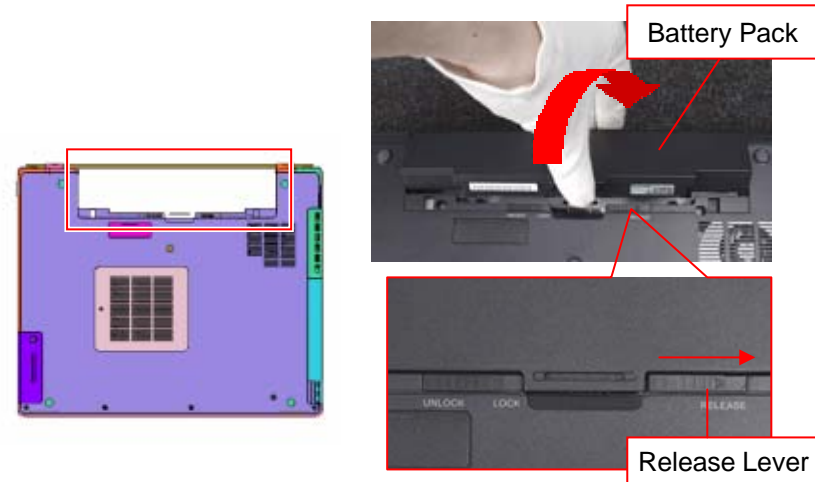

Slide the Release Lever to the right side, and turn over the Battery Pack to the rear side then remove it.

# HDD

1)

Screw: B20

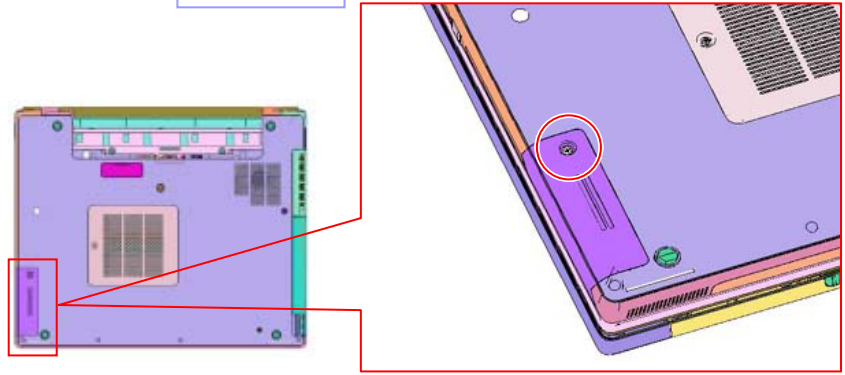

Remove the screw.

2)

HDD

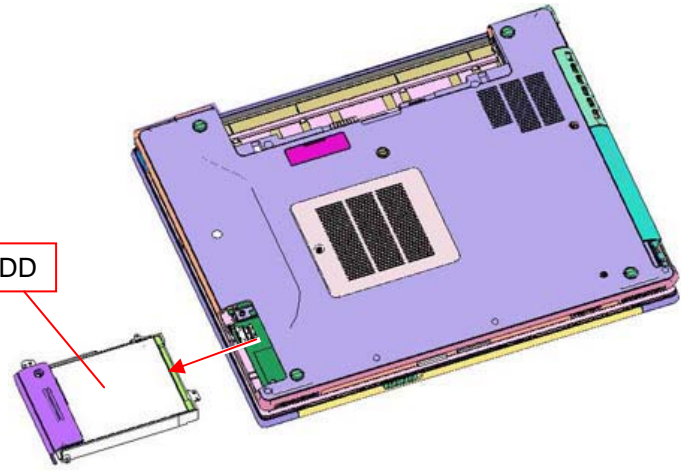

Remove the HDD.

# Parts of the HDD

1)

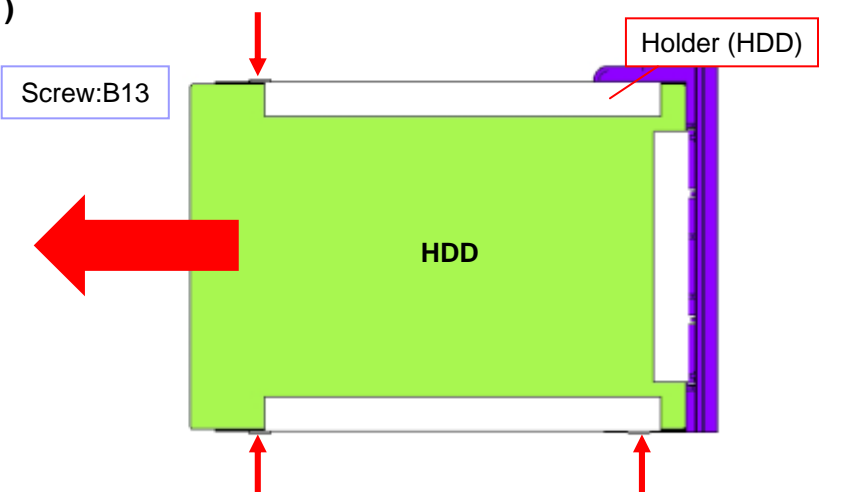

A diagram showing a green HDD being removed from a purple holder. Three red arrows point to screws on the top, bottom-left, and bottom-right of the HDD. A red arrow on the left points away from the HDD. Labels include 'Screw: B13' in a blue box, 'Holder (HDD)', and 'HDD'.

Remove the three screws, and remove the HDD from the Holder (HDD).

2)

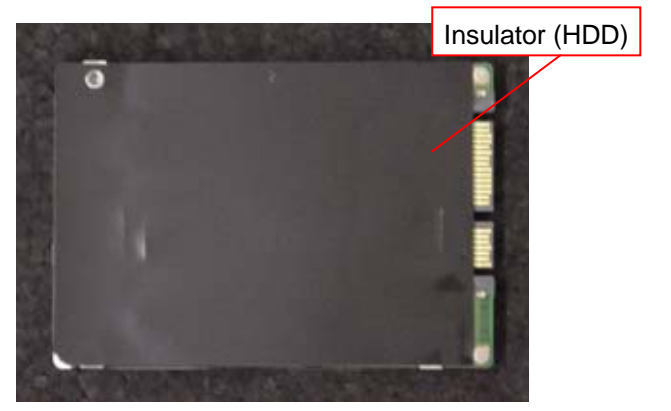

A photograph of the back of a HDD with a black insulator being peeled off. A red arrow points to the insulator. Label: 'Insulator (HDD)'.

Peel off the Insulator (HDD).

3)

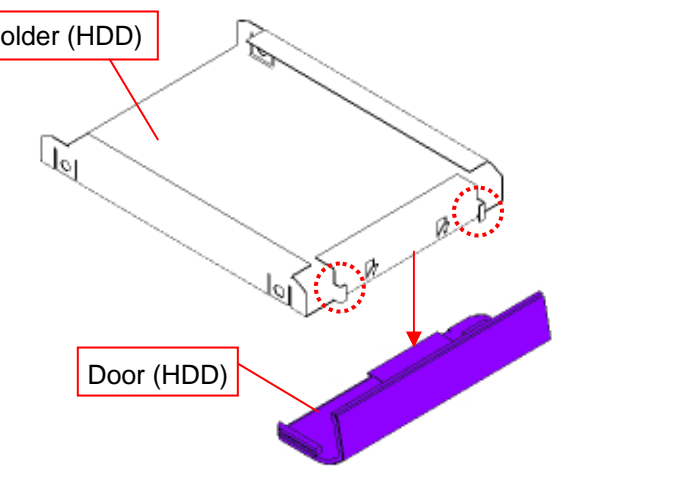

A diagram showing a white HDD holder and a purple door. Two red dashed circles on the holder indicate detent locations. A red arrow points from the door to these locations. Labels include 'Holder (HDD)' and 'Door (HDD)'.

Remove the Door (HDD) while disengaging the detent (two places).

# Cover (Memory), Memory

1)

Screw:B7

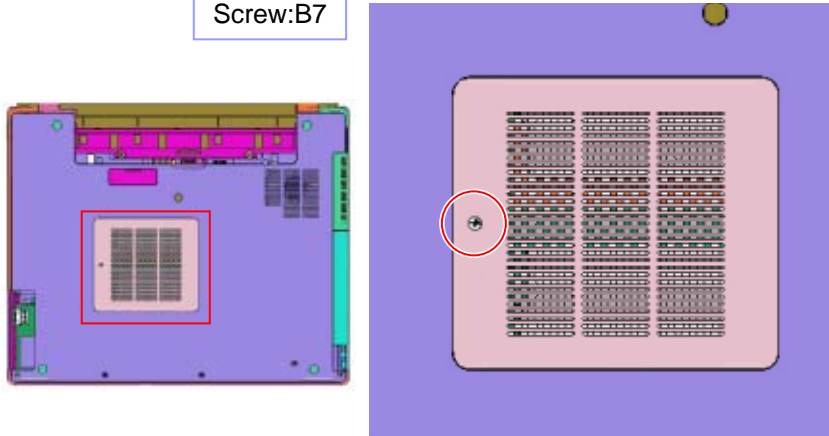

Remove the screw.

2)

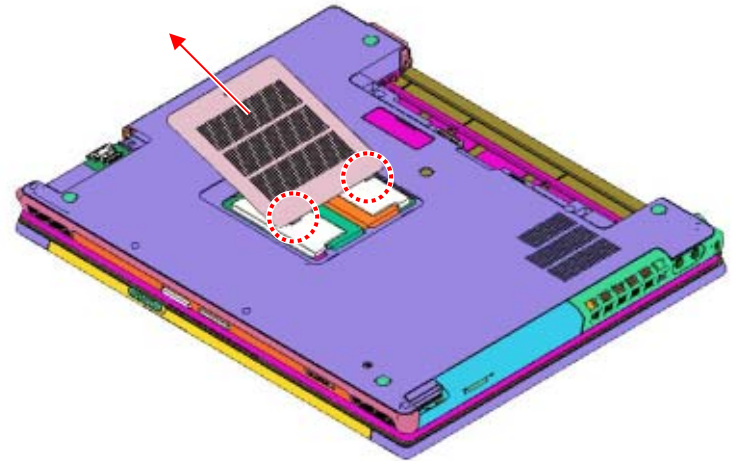

Remove the Cover (Memory) while disengaging the detent (two places).

3)

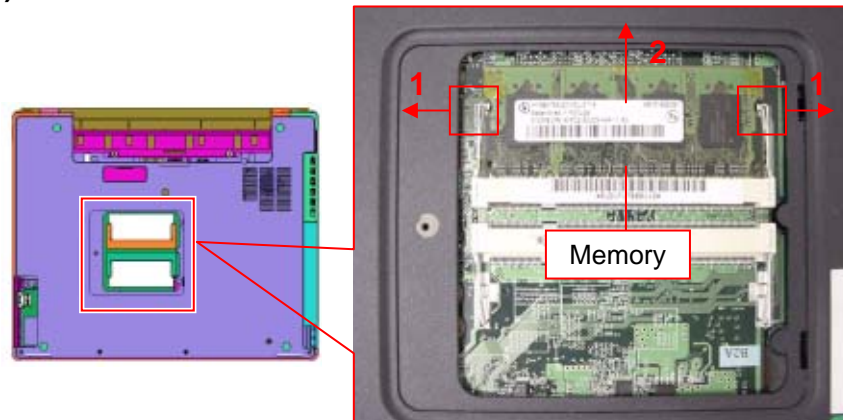

Outspread the tabs (arrow 1), and pull out the Memory diagonally upward (arrow 2).

*\*When two Memory are installed, remove the other side of the Memory in the way as above.*

# Optical Disc Drive, Screws

1)

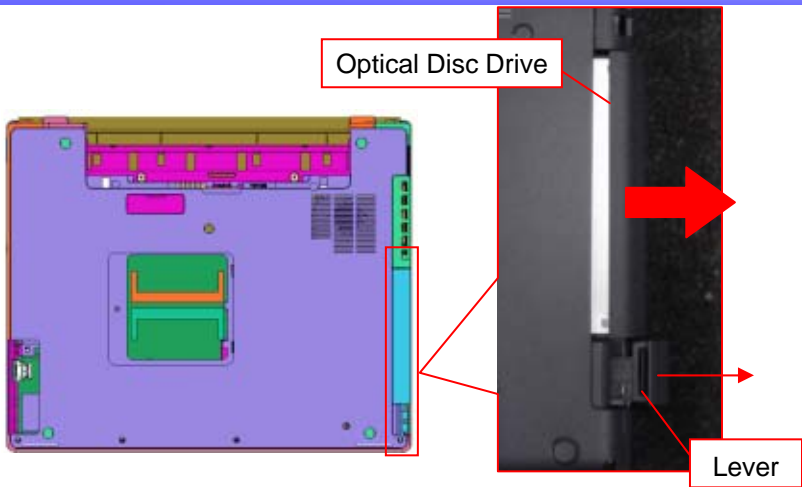

Push the lever once and pull out it in the direction of the arrow, then remove the Optical Disc Drive.

### Remark

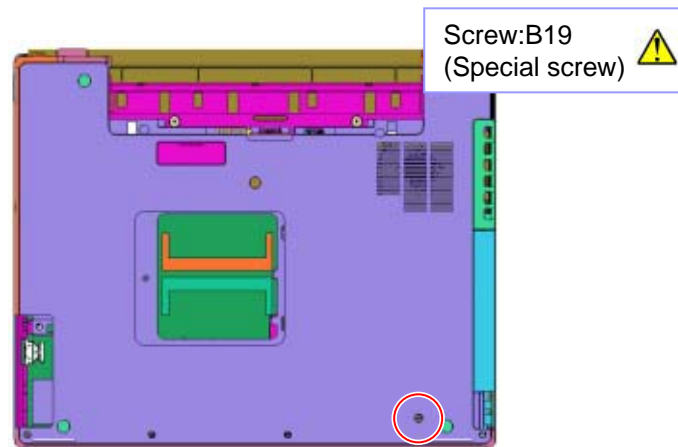

When there is a screw in the position of figure, remove the Optical Disc Drive after removing the screw.

2)

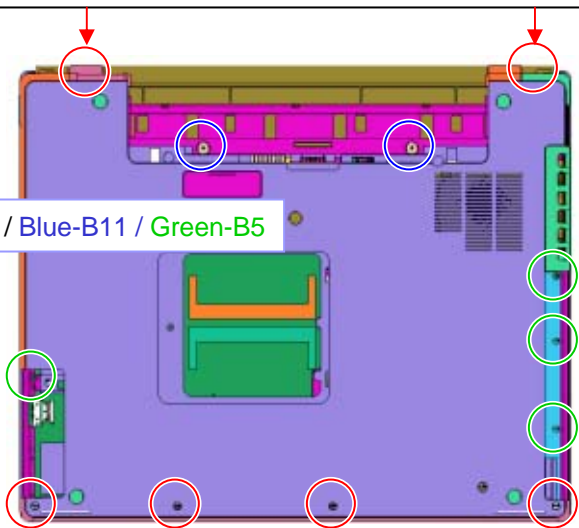

Remove the 12 screws.

# Hood (Keyboard)

1)

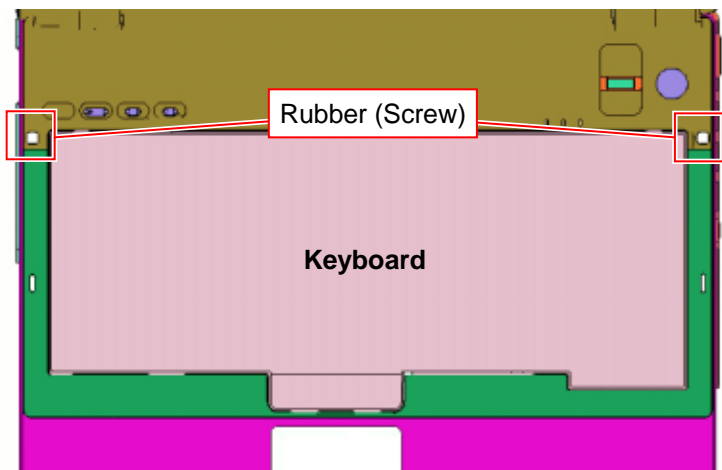

Peel off the Rubber (Screw) (two places).

2)

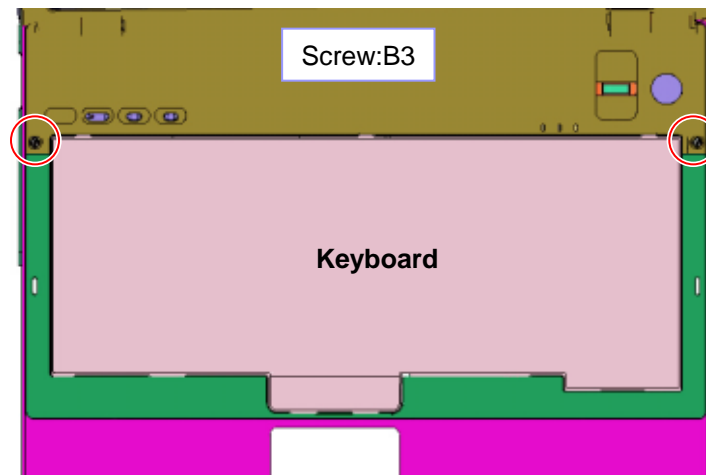

Remove the two screws.

3)

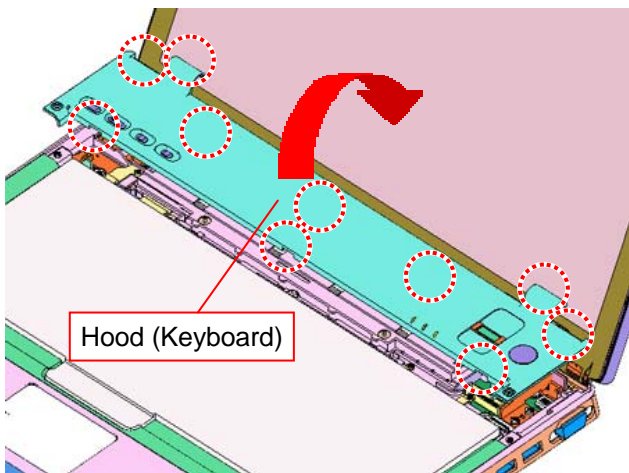

Turn over the Hood (Keyboard) to the rear side.

\* The detents (10 places) are engaged.

4)

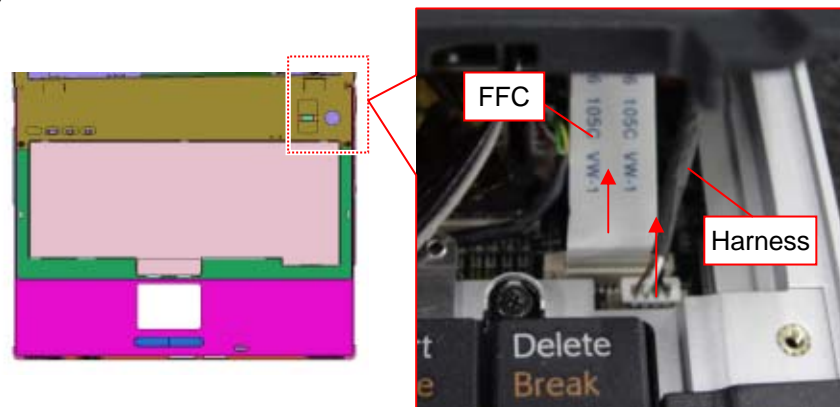

Disconnect the FFC and the Harness.

\*FFC --- Slide the lock lever upward and release the lock.

Harness --- Pull out it upward.

# Parts of the Hood (Keyboard) -1

1)

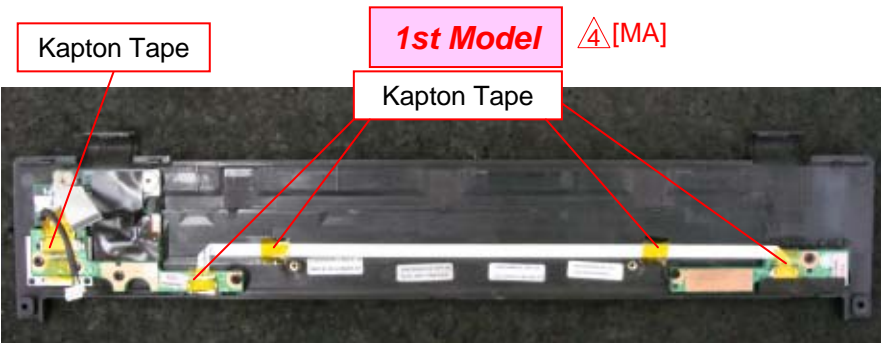

Peel off the Kapton Tape.  
 \*1st Model --- Five places  
 Other --- One place

2)

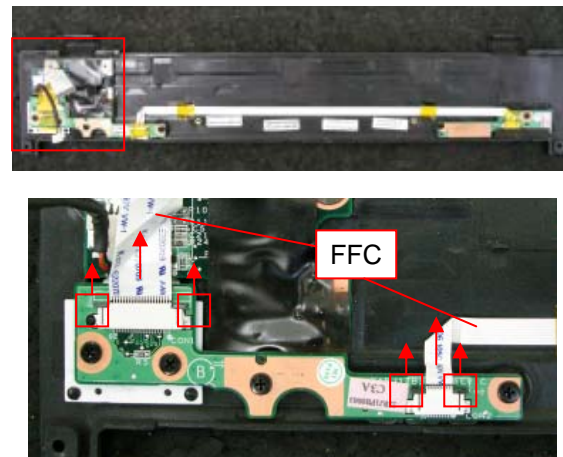

Disconnect the FFC (two places).  
 \*Slide the lock lever in the direction of the arrow, and release the lock.

3)

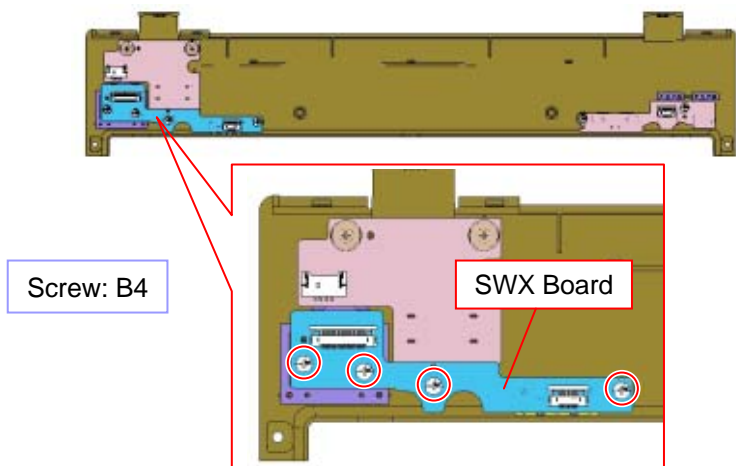

Remove the four screws and the SWX Board.

4)

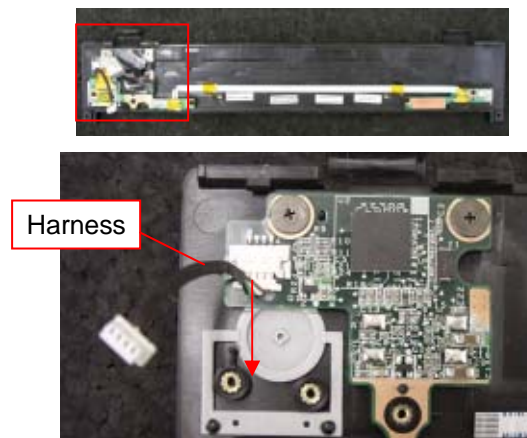

Disconnect the Harness.



# Parts of the Hood (Keyboard) -2

5)

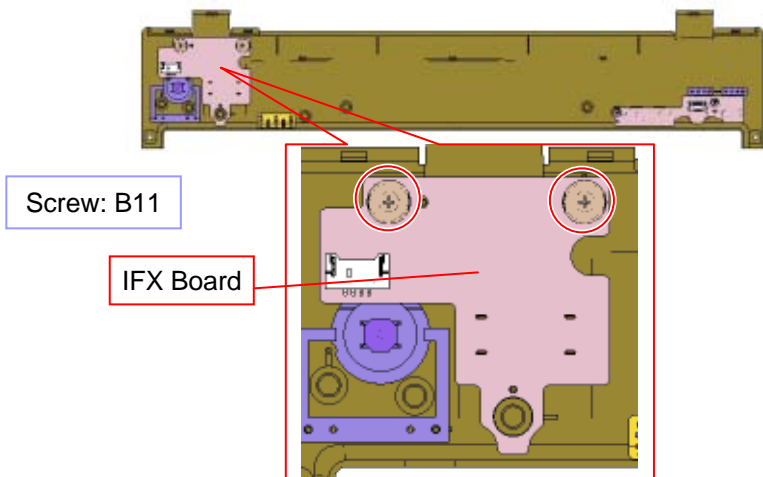

Remove the two screws and the IFX Board.

6)

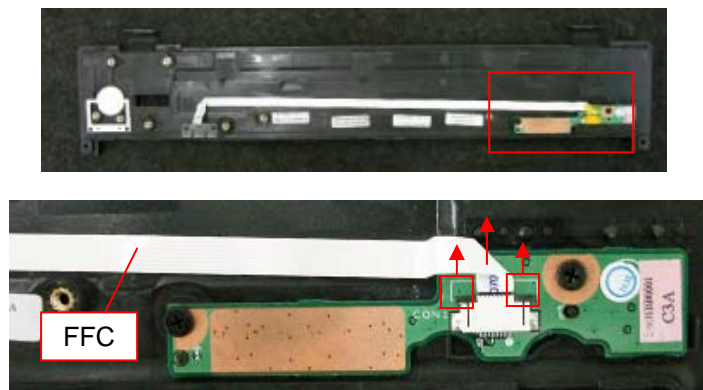

Disconnect the FFC.

\*Slide the lock lever in the direction of the arrow and release the lock.

Remark  [MA]

**2nd Model**

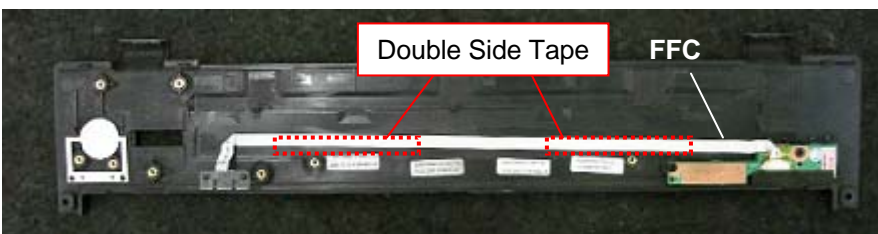

The FFC is secured with double side tape (two places).

7)

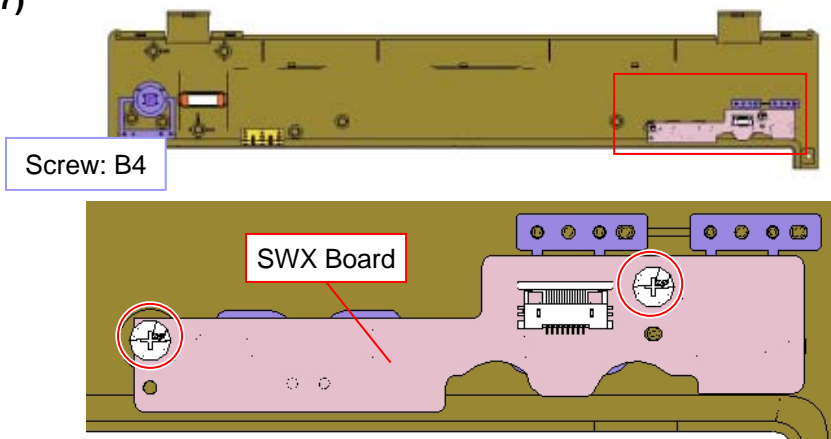

Remove the two screws and the SWX Board.

# Keyboard -1

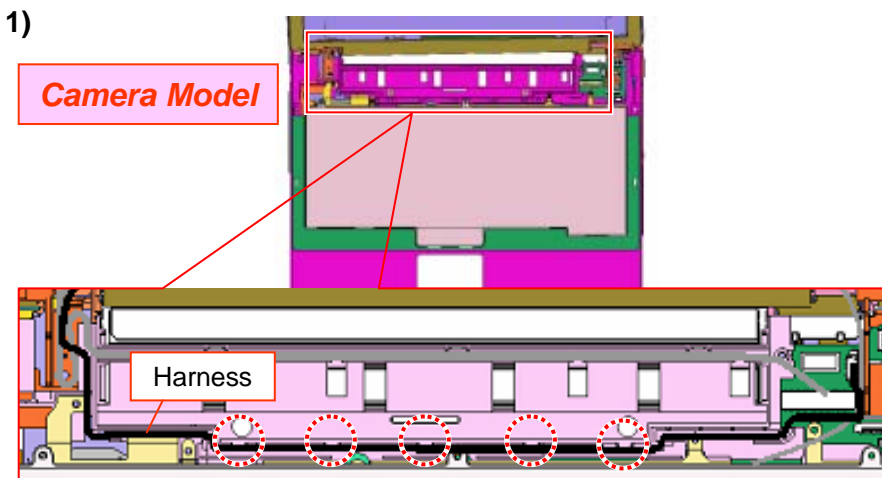

Release the Harness from the detent (five places).

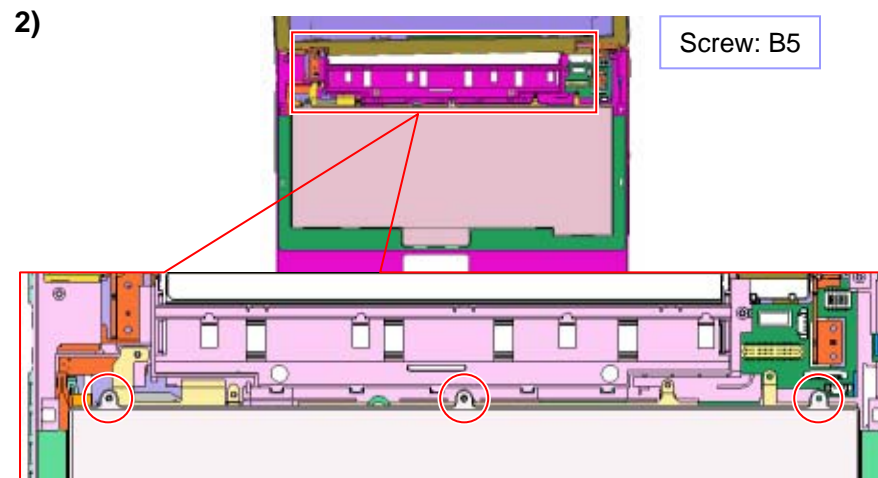

Remove the three screws.

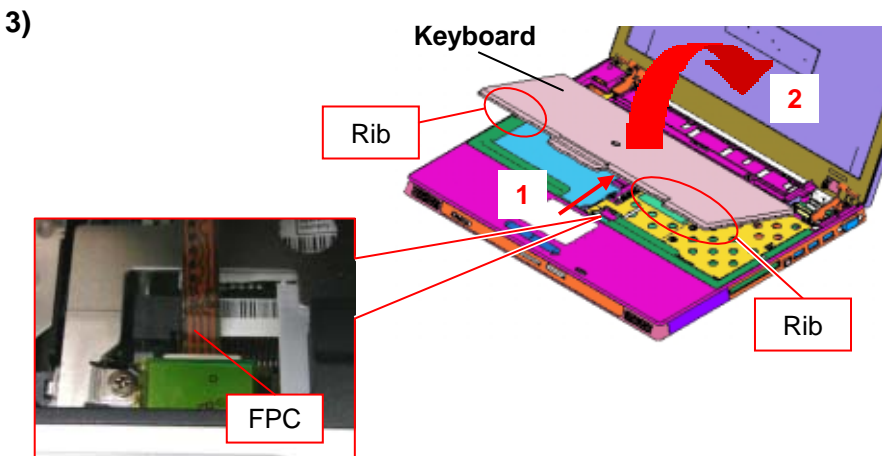

Release the rib (two places) by sliding the Keyboard in the direction of the arrow 1, and lift it from the front side lightly.

**\*Notice :** The FPC coming from the Keyboard is connected with Mother Board.

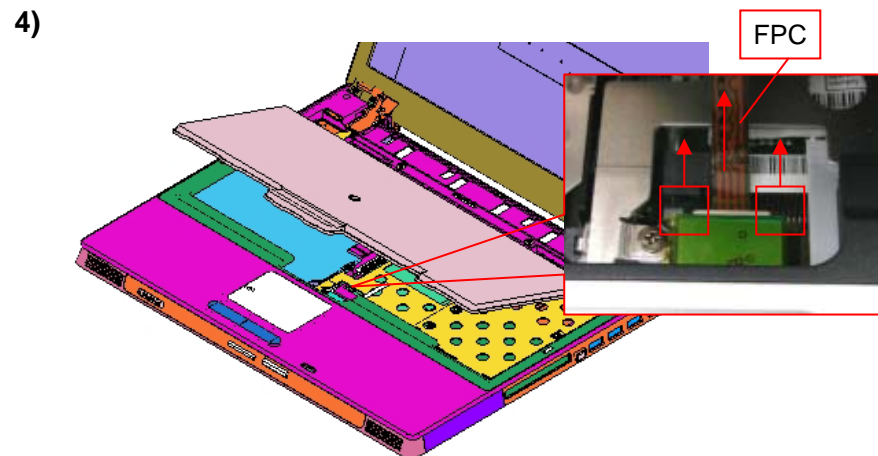

Slide the lock lever in the direction of the arrow and release the lock, then disconnect the FPC.

## Keyboard -2

5)

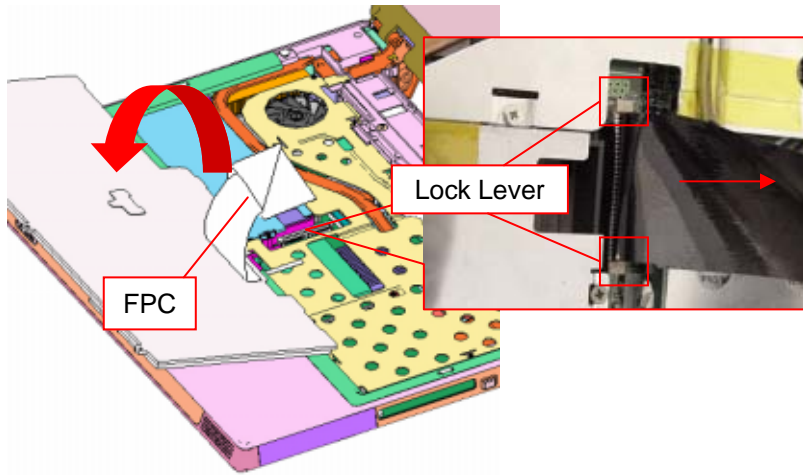

Turn over the Keyboard to the front side, and disconnect the FPC.

*\*Slide the lock lever upward and release the lock.*

# LCD Section -1

1)

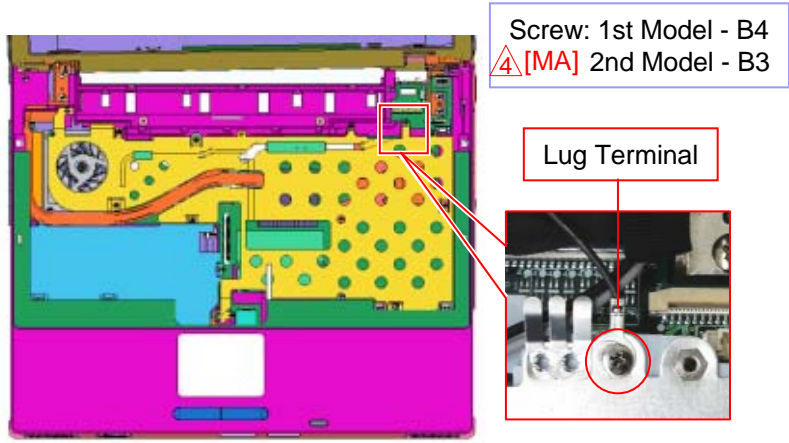

Remove the one screw.  
 \* It secures the lug terminal.

2)

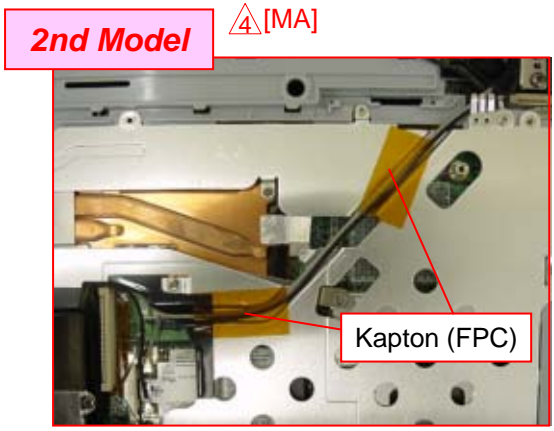
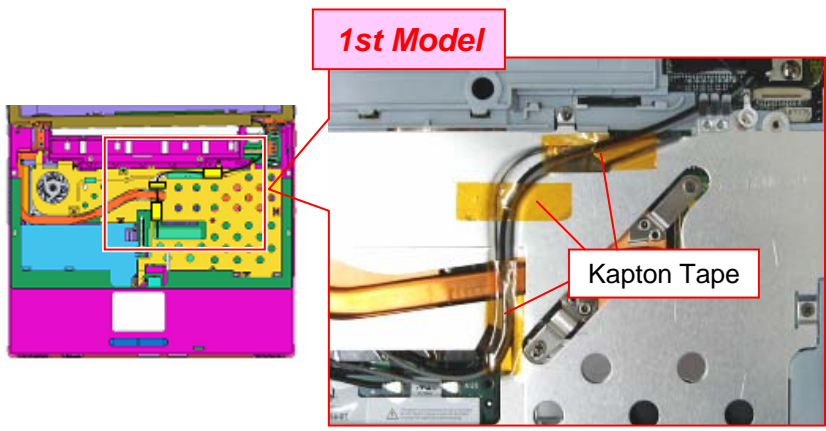

Peel off the Kapton Tape.  
 \*1st Model --- Three places  
 2nd Model --- Two places

# LCD Section -2

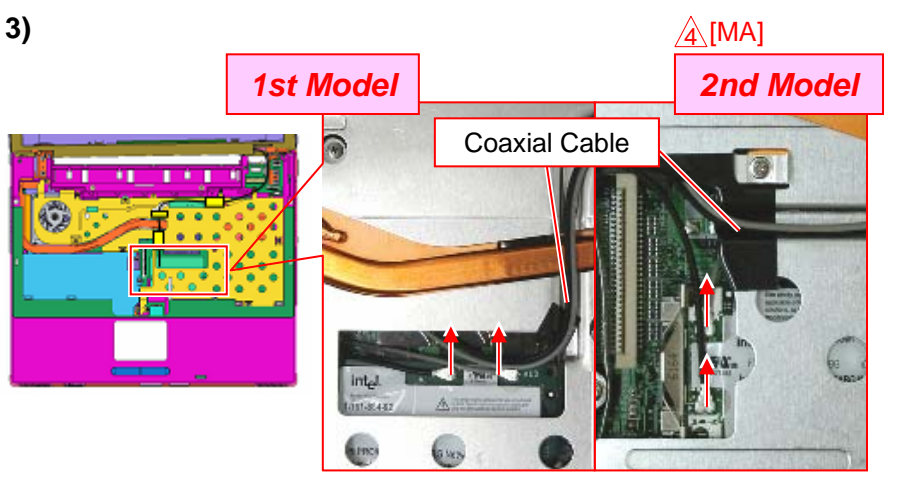

Disconnect the Coaxial Cable (two places).  
 \* Disconnect it **vertically**.

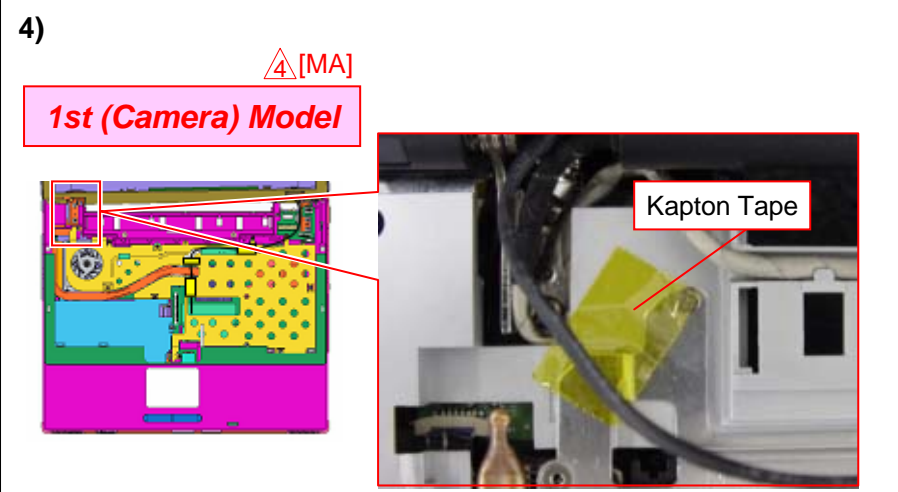

Peel off the Kapton Tape.

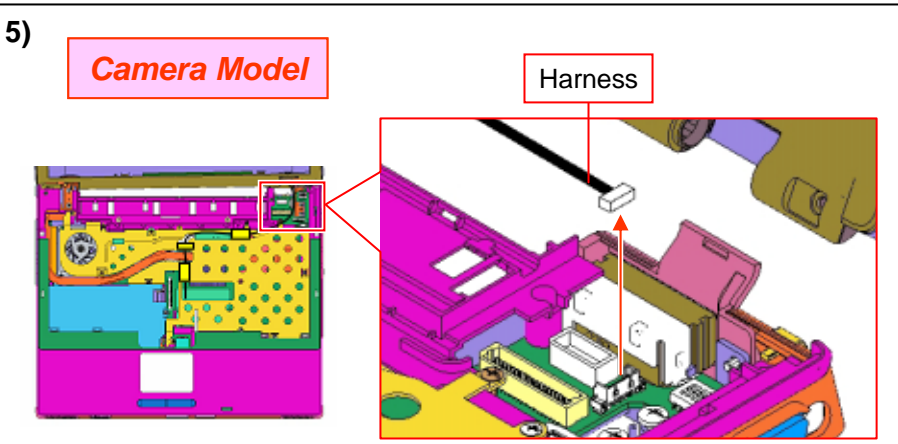

Disconnect the Harness upward.

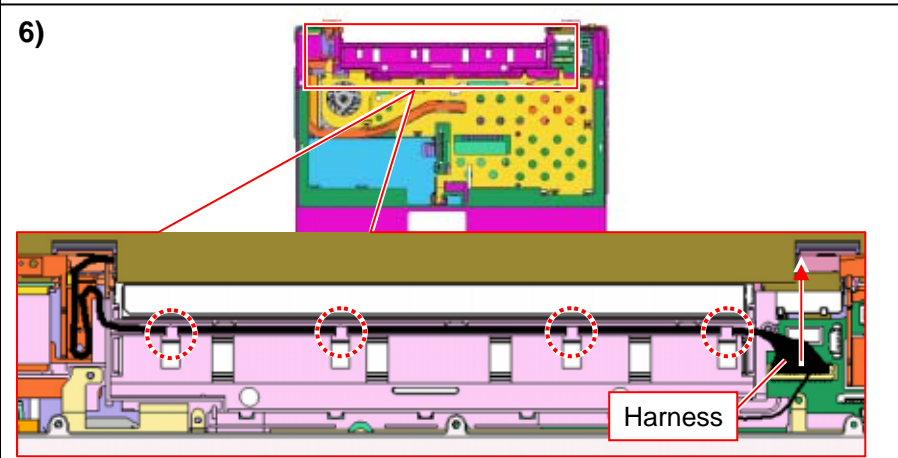

Disconnect the Harness upward and release it from the detent (four places).

# LCD Section -3

7)

1st (WAN (EXT)) Model

⚠️[MA]

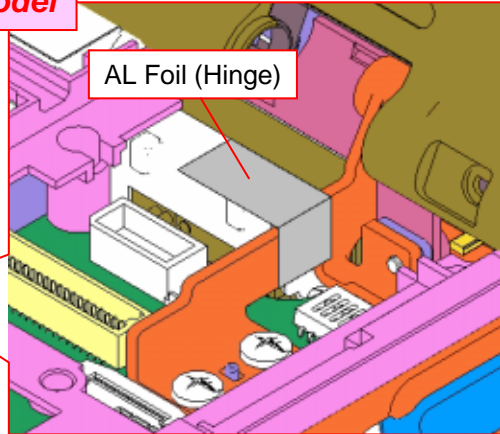

Peel off the AL Foil (Hinge).

8)

Screw: B21

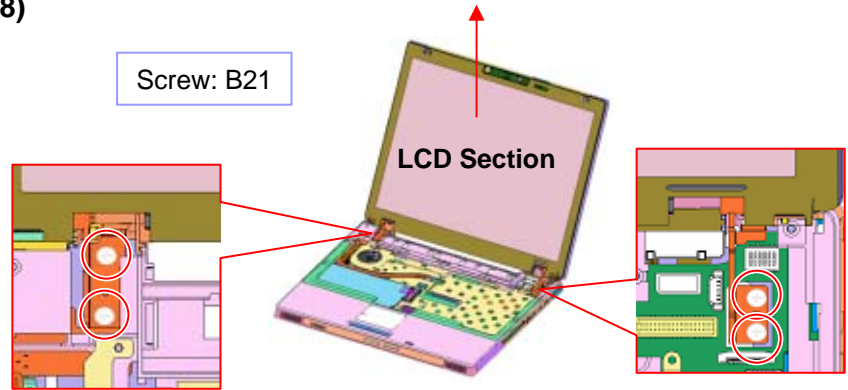

Remove the four screws and LCD Section.

# Bracket (KB EX)

1)

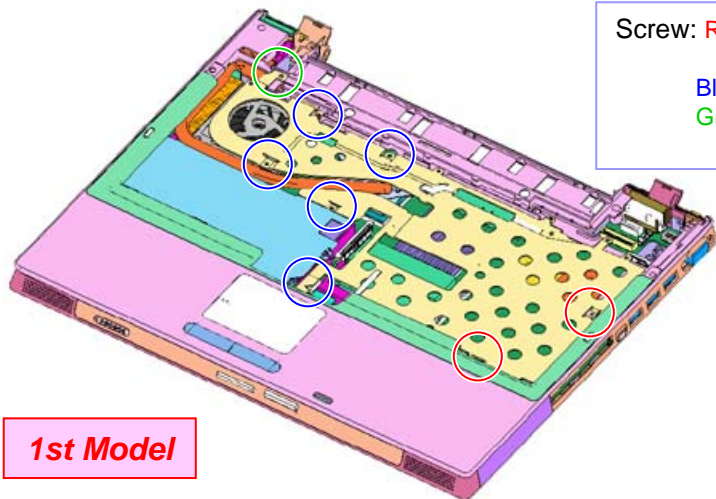

Screw: Red: 1st Model - B8  
 2nd Model - B30  
 Blue-B3  
 Green: 1st Model - B2  
 2nd Model - B31

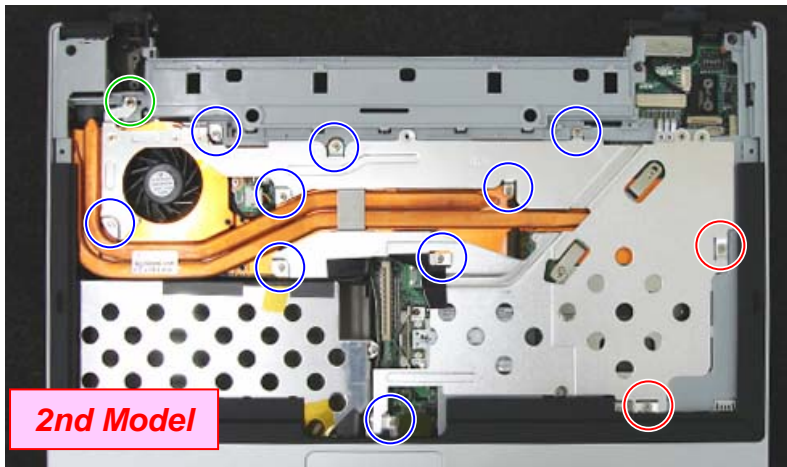

⚠ [MA]

Remove the screws.

\*1st Model --- 8 places  
 2nd Model --- 12 places

2)

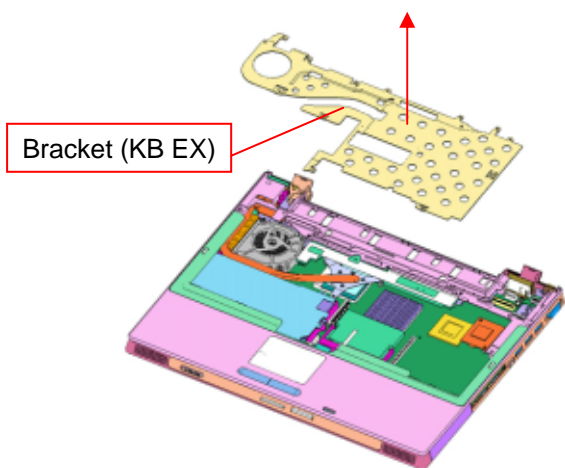

Remove the Bracket (KB EX).

# Palmrest

1)

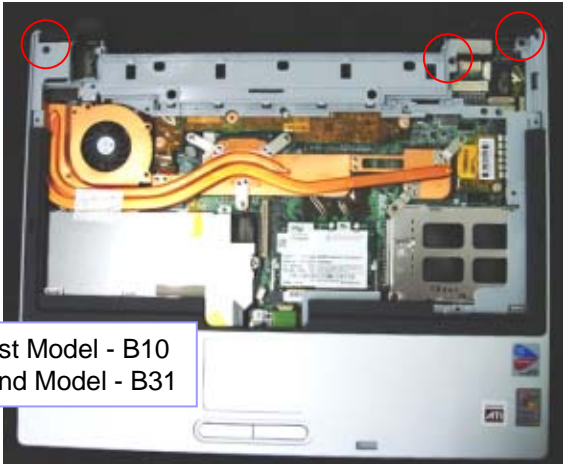

Screw: 1st Model - B10  
 ⚠️ [MA] 2nd Model - B31

Remove the three screws.

2)

**Bluetooth Model**

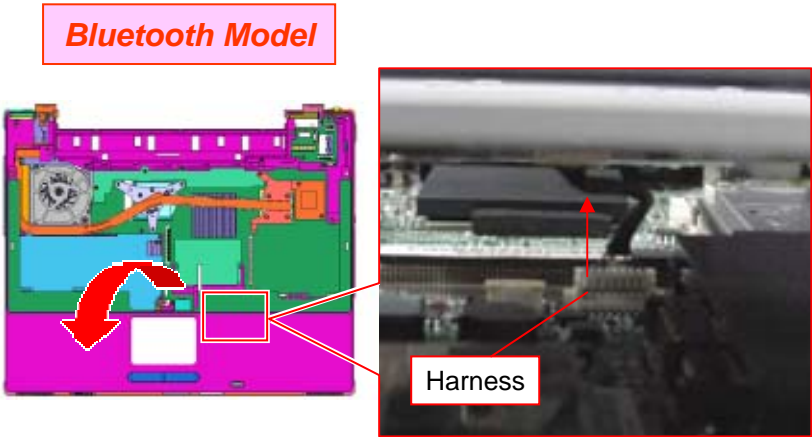

Harness

Turn over the Palmrest to the front side lightly and disconnect the Harness (one place) vertically.

3)

**Felica Model**

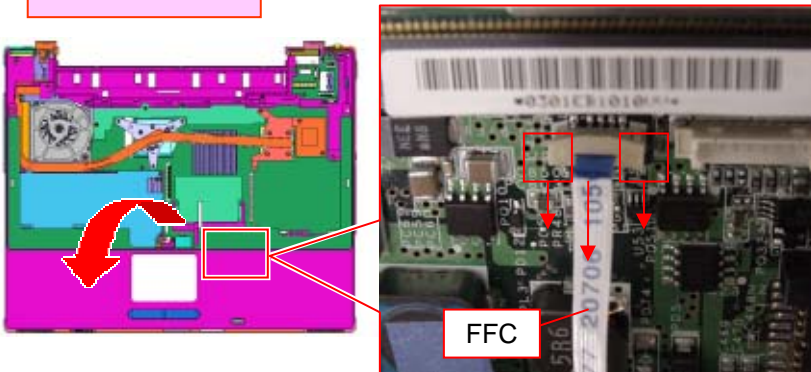

FFC

Turn over the Palmrest to the front side lightly and slide the lock lever upward to release the lock. And then Disconnect the FFC.

4)

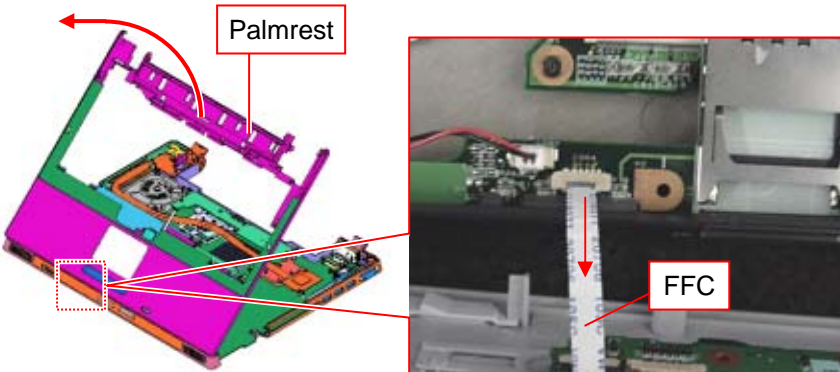

Palmrest

FFC

Disconnect the FFC. Then remove the Palmrest.



# Heatsink -1

⚠️ [MA]

1) **1st Model**

⚠️ [MA]

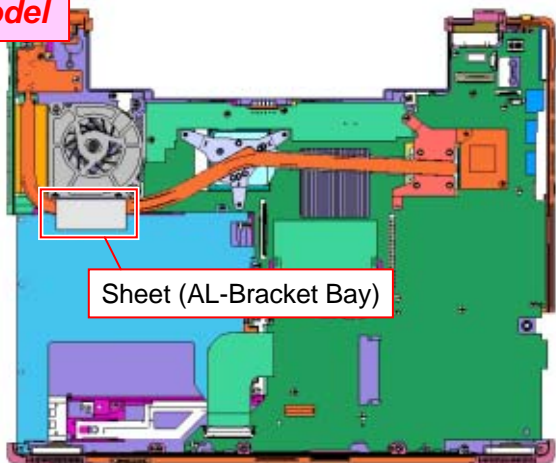

Peel off the Sheet (AL-Bracket Bay).

2) **1st Model** ⚠️ [MA]

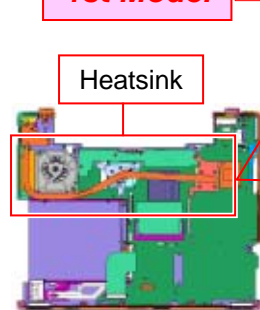

Screw: Red-B3 / Blue-B8

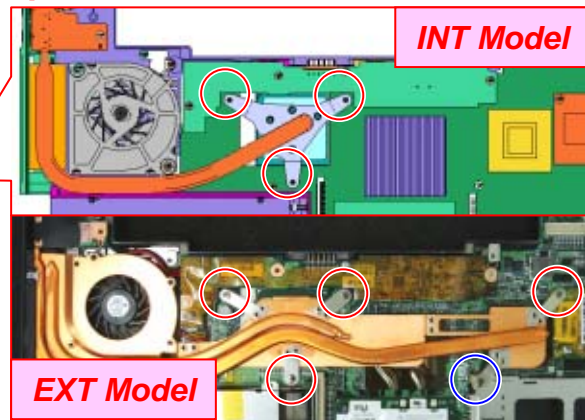

Remove the screws.  
\*INT Model --- Three places  
EXT Model --- Five places

3) ⚠️ [MA]

**2nd Model**

Heatsink

**INT Model**

**EXT Model**

Screw: Red-B3 / Blue-B30

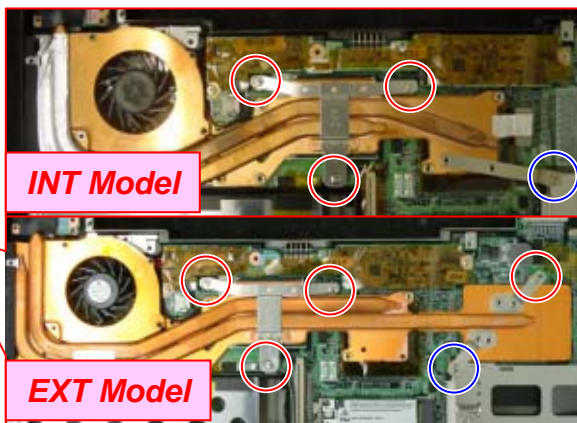

Remove the screws.  
\*INT Model --- Four places  
EXT Model --- Five places

4) ⚠️ [MA]

**2nd Model**

Heatsink

Harness

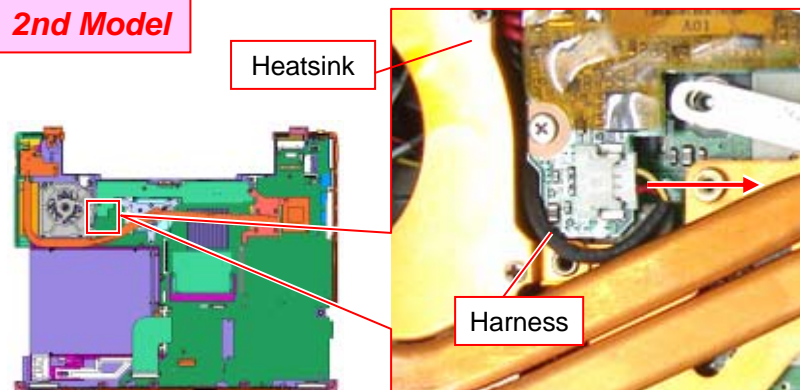

Disconnect the Harness.

# Heatsink -2

5)

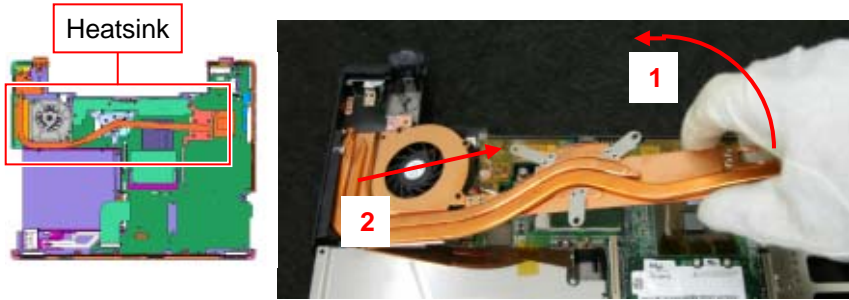

Lift the right side of the Heatsink and remove it in the direction of the arrow 2.

6)

1st (EXT) Model

⚠️[MA]

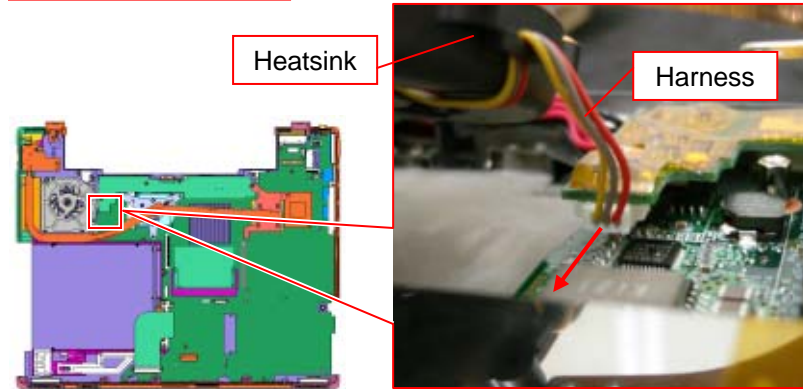

Disconnect the Harness.

# Fan **1st (INT) Model**

1)  [CHG]

Screw: Red-B15 / Blue-B24

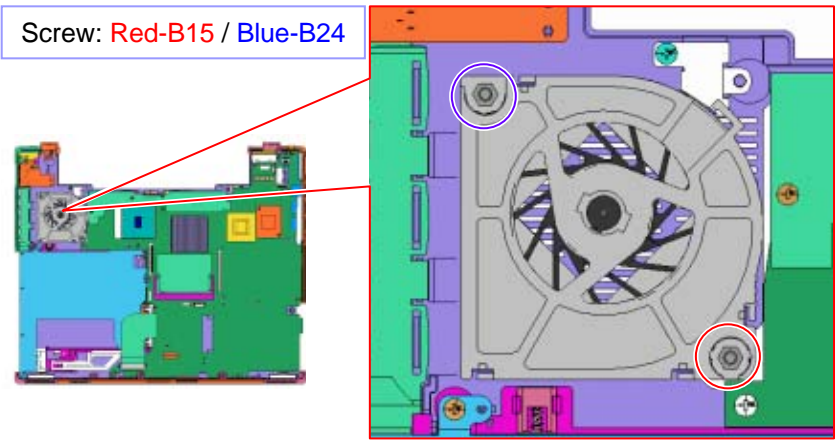

Remove the two screws.  
\*Use a 4 mm socket wrench for B15.

2)

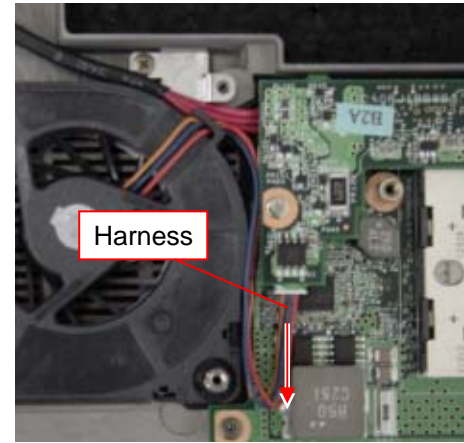
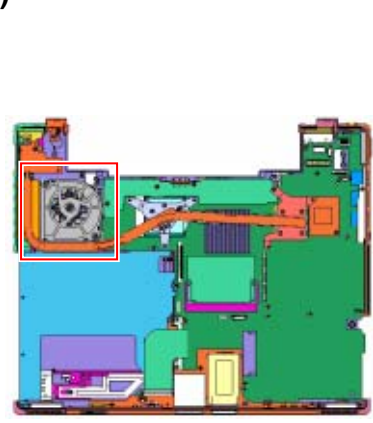

Disconnect the Harness.

3)

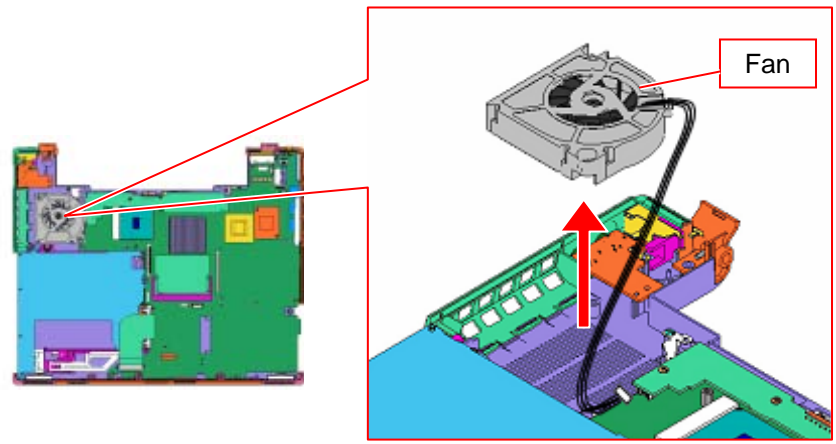

Remove the Fan.

# PC Card Connector, Guide (HDD)

1)

Screw: 1st Model - B8  
⚠️[MA] 2nd Model - B30

⚠️[MA]

1st (INT) Model

Connector

PC Card Connector

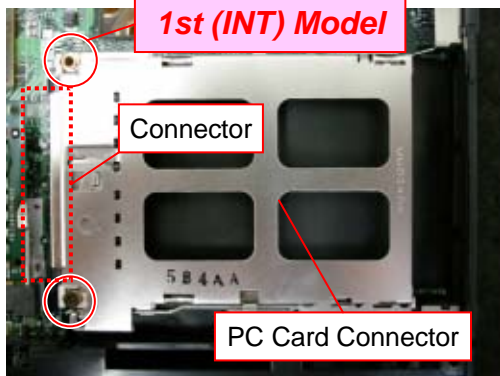
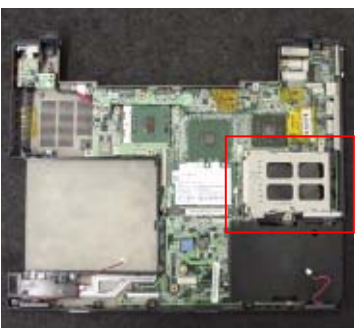

Remove the screws, and remove the PC Card Connector while disconnecting the connector.  
\* 1st (INT) Model --- Two places  
Other --- One place

2)

⚠️[MA]  
2nd Model

Screw: B3

Sink (Choke)

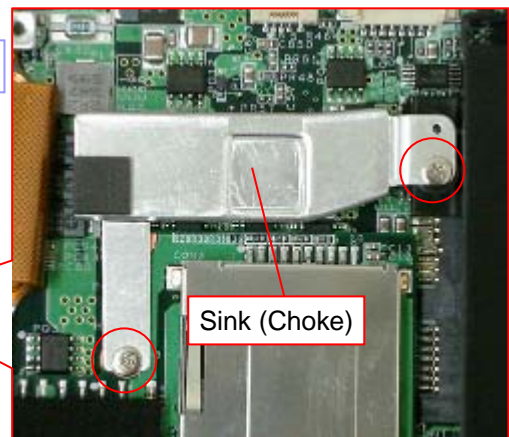
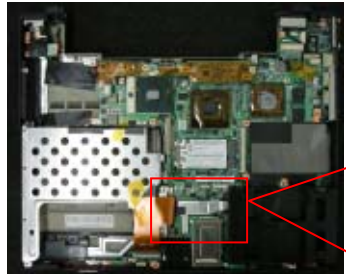

Remove the two screws, and remove the Sink (Choke).

3)

Screw: B10

Guide (HDD)

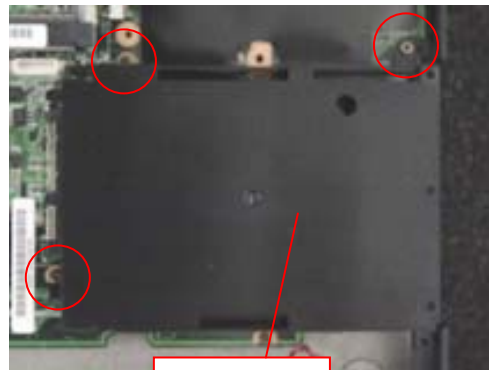
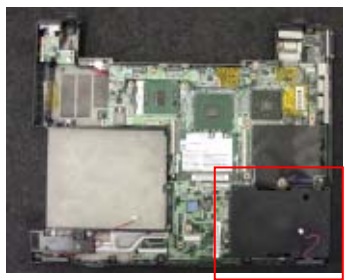

Remove the three screws and the Guide (HDD).

# IFX-431 Board

1)

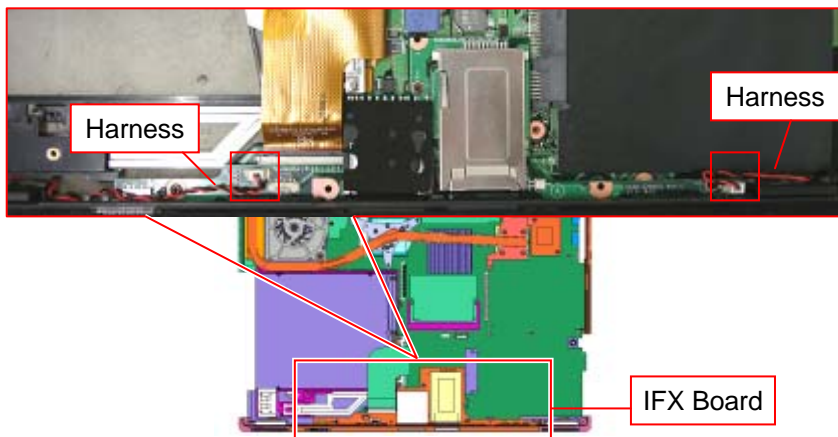

Disconnect the Harness (two places) vertically.

2)

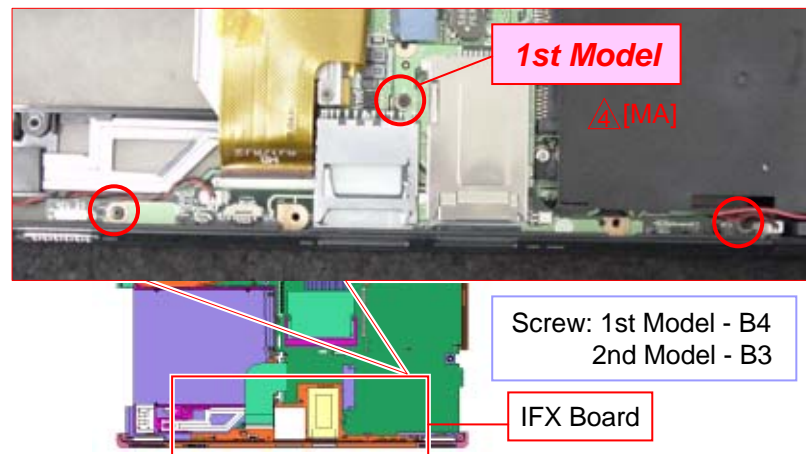

Remove the screws.

\*1st Model --- Three places  
2nd Model --- Two places

3)

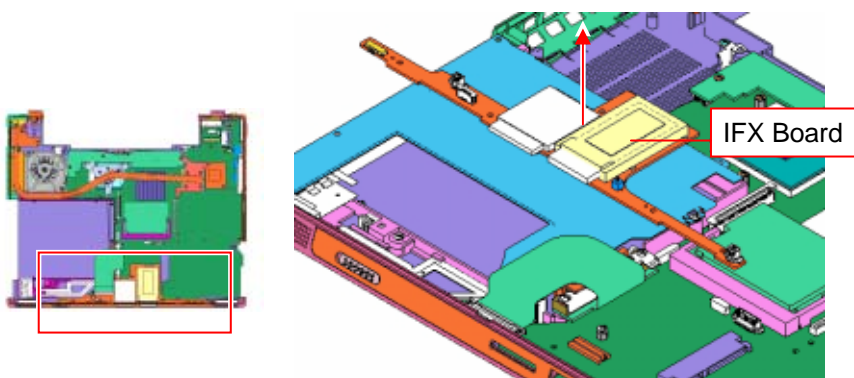

Remove the IFX Board.

\*There is a connector on the rear.

### Remark

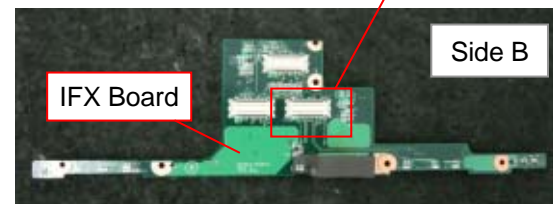
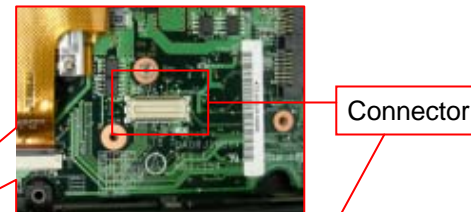
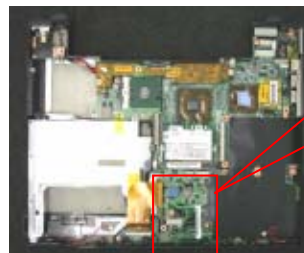

Position of the Connector

# Bracket (ODD) -1

⚠️[MA]

1)

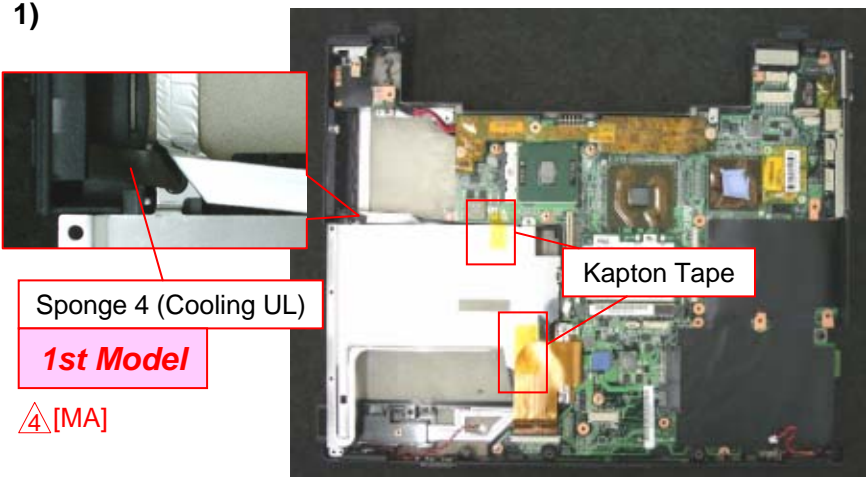

Peel off the Kapton Tape (two places), and Sponge 4 (Cooling UL) (1st model only).

2) ⚠️[MA]

2nd Model

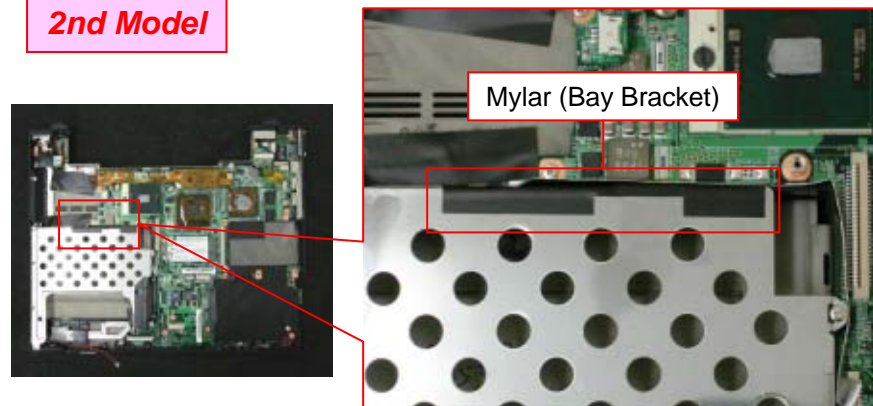

Peel off the Mylar (Bay Bracket).

3)

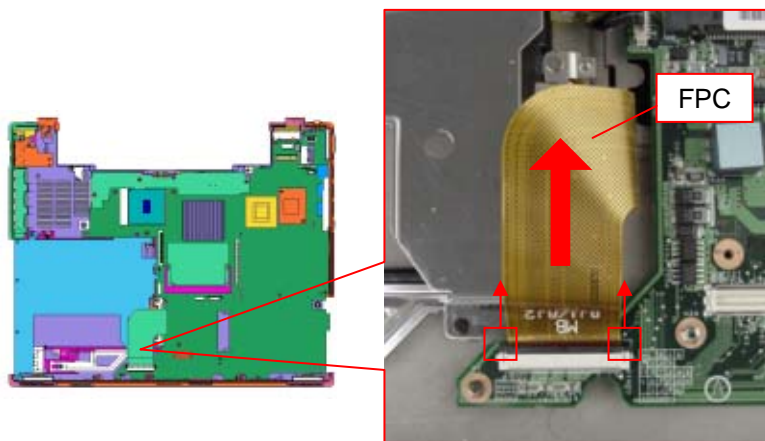

Slide the lock lever in the direction of the arrow to release the lock, and disconnect the FPC.

4)

Screw: 1st Model - B2  
⚠️[MA] 2nd Model - B33

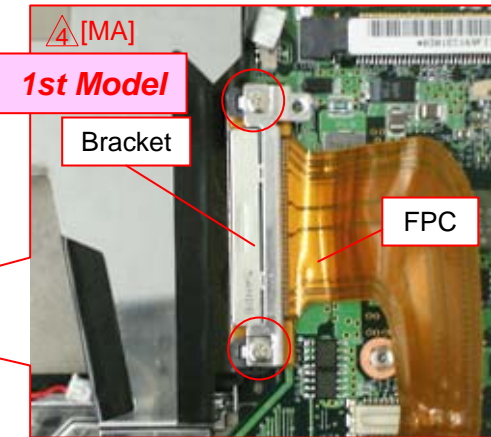

Remove the two screws, and remove the Bracket and FPC.  
\* The Procedure of removing the Bracket is only for 1st Model.

## Bracket (ODD) -2

5)

Screw: Red-B4

Blue: 1st Model - B8

⚠️[MA] 2nd Model - B30

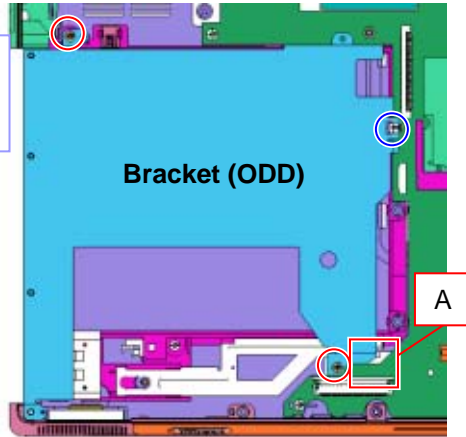

Remove the three screws. And remove the Bracket (ODD) while taking out the A portion from under the Mother Board.

# PWS-51 Board

1) **1st (WAN) Model**

⚠️ [MA]

Tape (Charger/B)

PWS Board

Peel off the Tape (Charger/B).

2) ⚠️ [MA]

**2nd Model**

Sheet (AL-DC Cable)

Mylar (FFC)

Peel off the Sheet and Mylar.

3)

Screw: B3

Connector

Connector

PWS Board

Remove the three screws and the PWS Board.  
\* There are connectors (two places) on the rear.

4)

Harness

Disconnect the Harness.



# Modem Card

1st Model ⚠️[MA]

1)

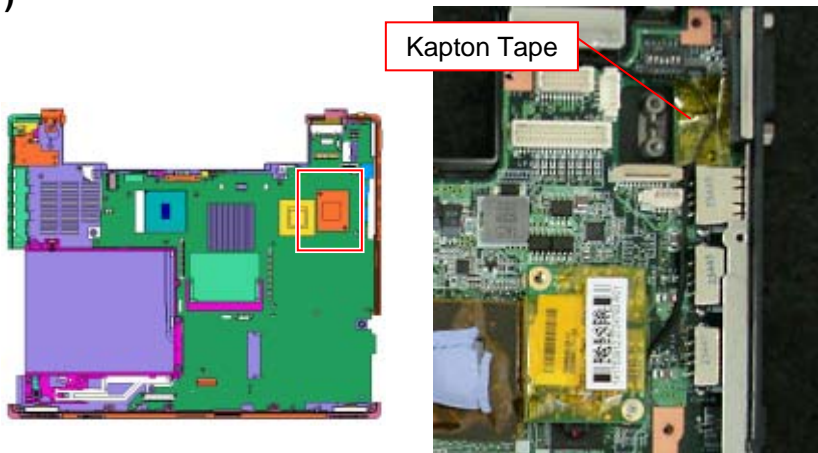

Kapton Tape

Peel off the Kapton Tape.

2)

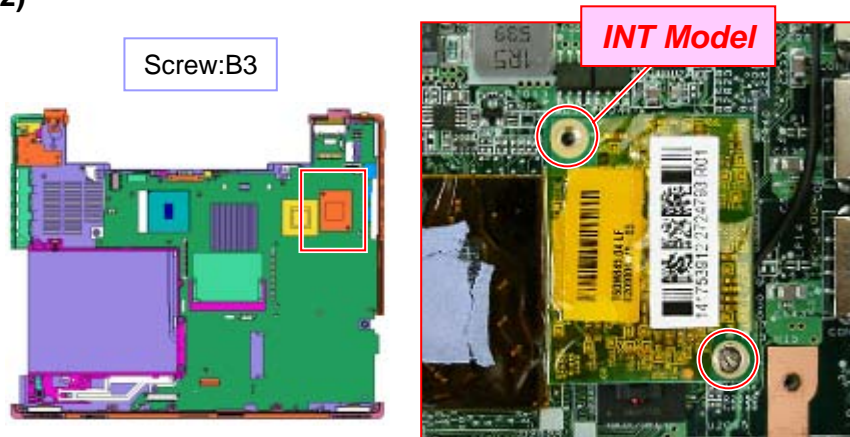

Screw:B3

INT Model

Remove the screws.

\*INT Model --- Two places  
EXT Model --- One place

3)

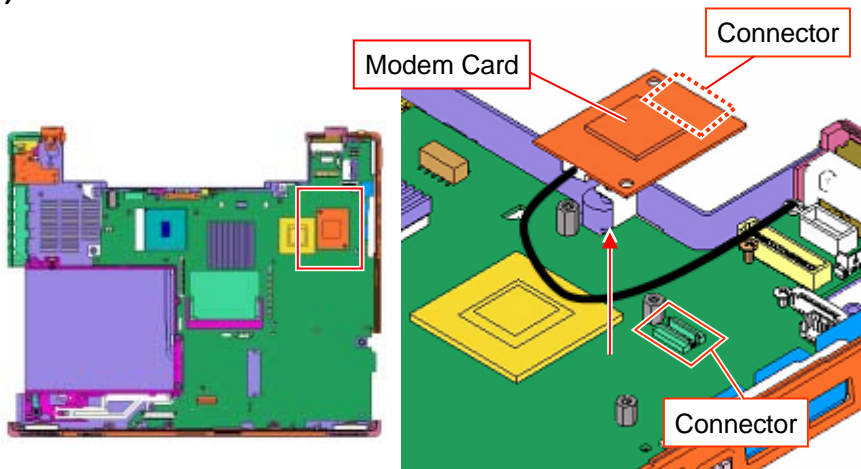

Modem Card

Connector

Connector

Remove the Modem Card.

4)

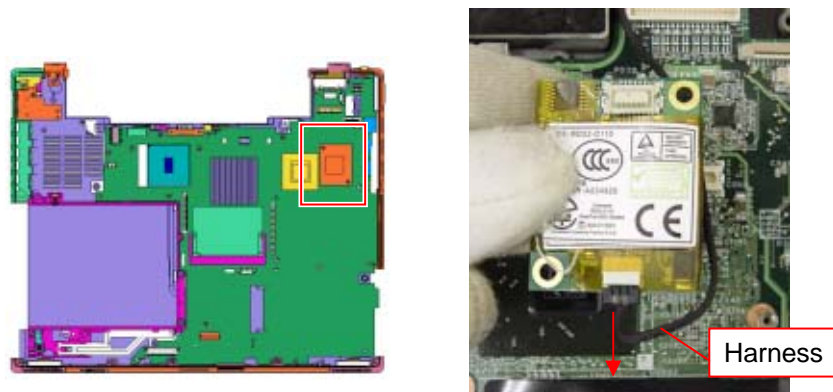

Harness

Disconnect the Harness.

## CPU

1)

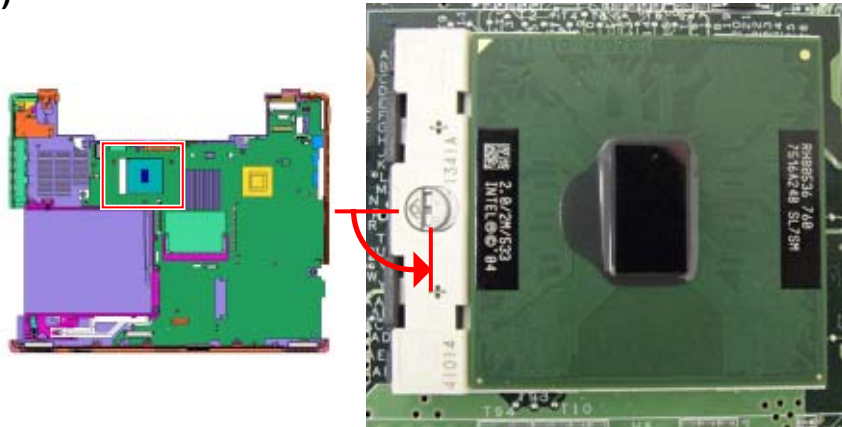

Rotate the lock screw in a counter clockwise direction by 90 degrees, and release the lock.

*\*Use a 4 mm flat-blade screwdriver.*

2)

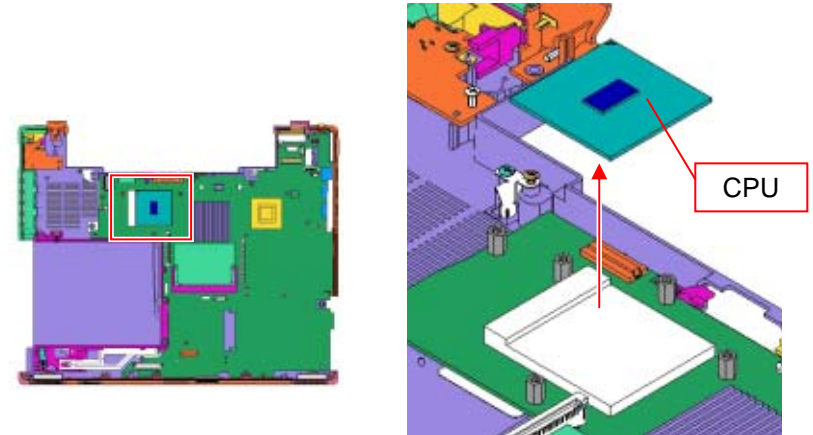

Remove the CPU vertically.

*\*Be careful not to bend the pins.*

# Escutcheon (Front), Speaker

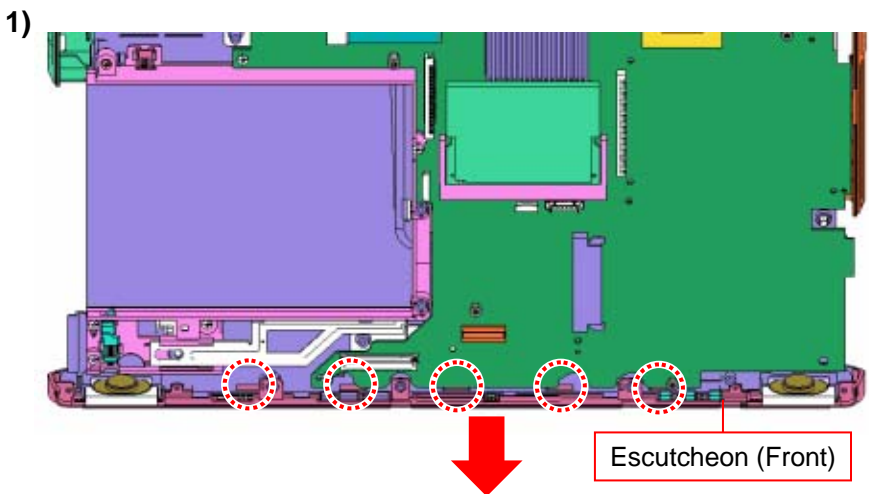

Remove the Escutcheon (Front) while disengaging the detent (five places).

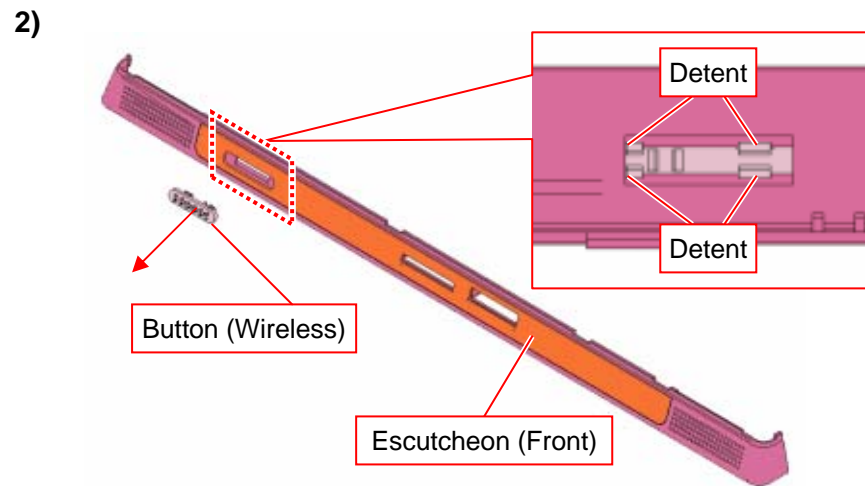

Remove the Button (Wireless) while disengaging the detent (four places).

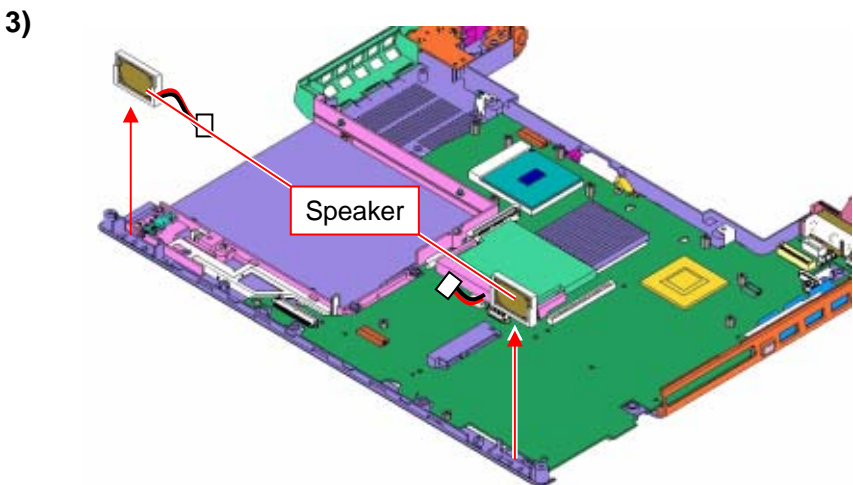

Remove the Speaker (two places).

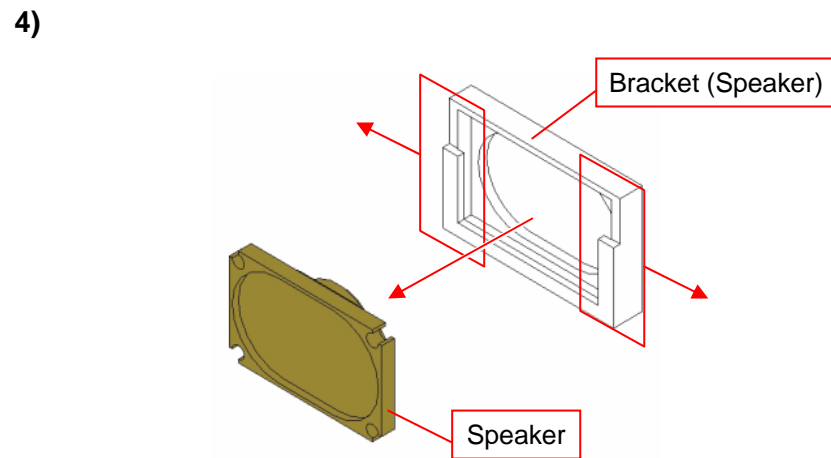

Outspread both sides of the Bracket (Speaker) and remove the Speaker.

# Mother Board -1

1)

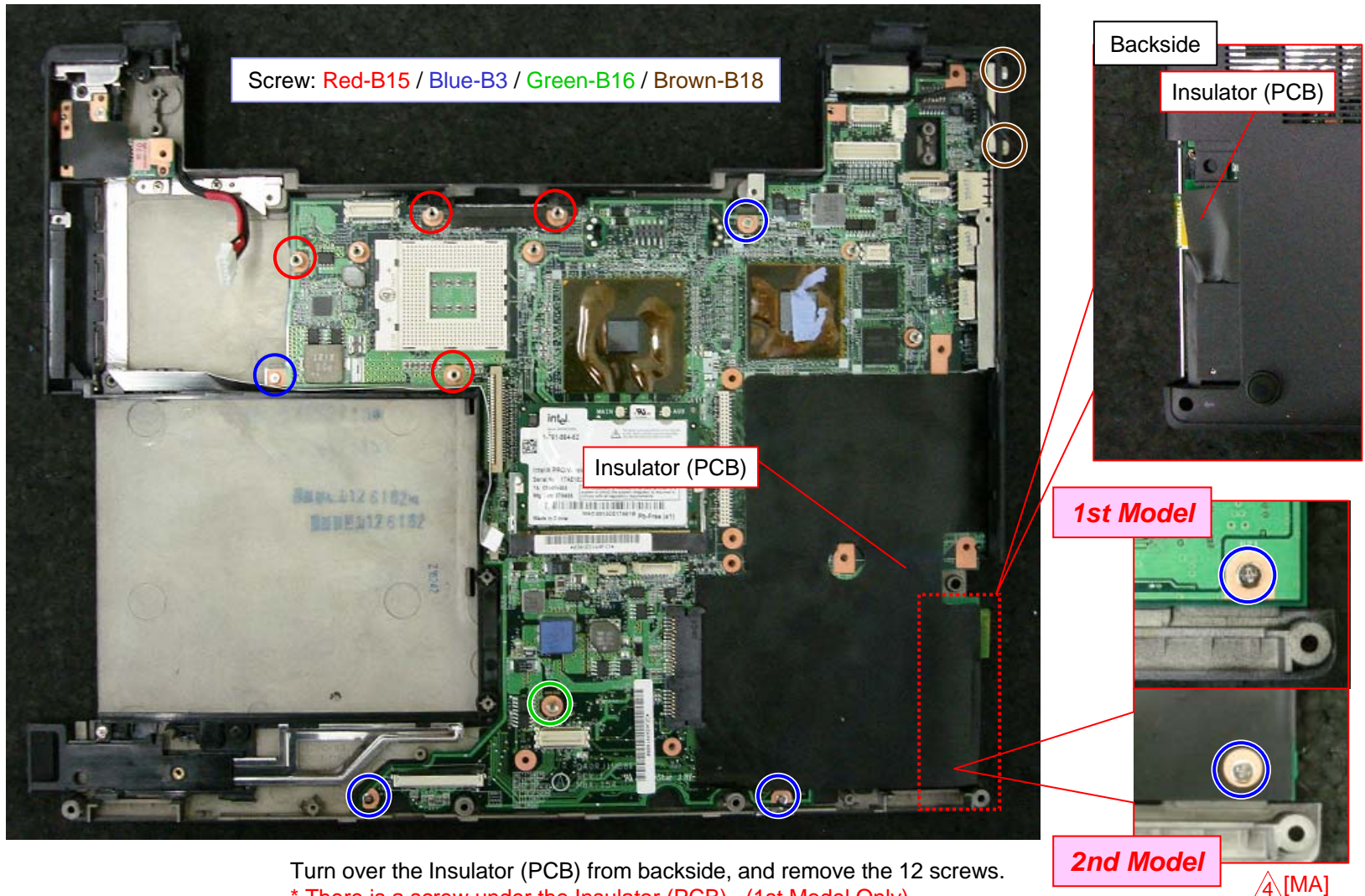

Turn over the Insulator (PCB) from backside, and remove the 12 screws.

\* There is a screw under the Insulator (PCB). (1st Model Only)

\* Use a 4 mm socket wrench for B15 and B16.

\* Use a 5 mm socket wrench for B18.

# Mother Board -2

2)

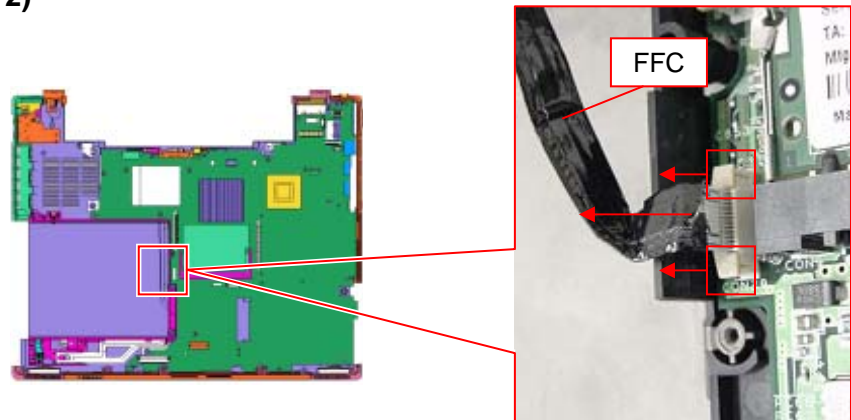

Slide the lock lever upward two release the lock and disconnect the FFC.

3)

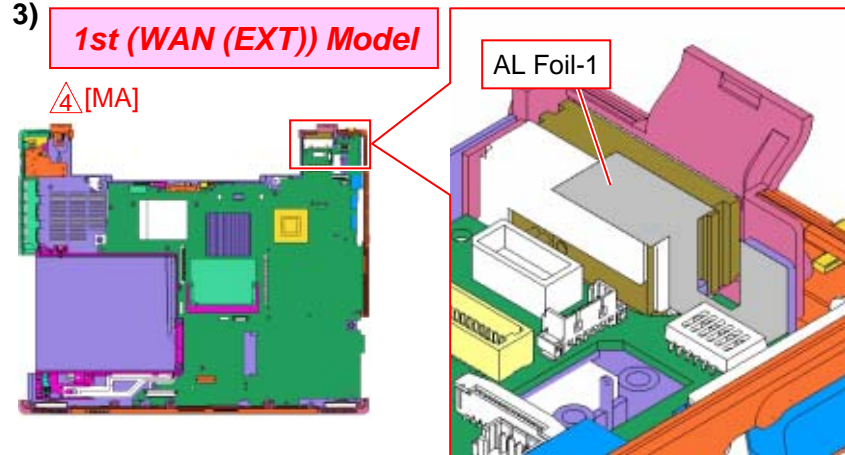

Peel off the AL Foil-1.

4)

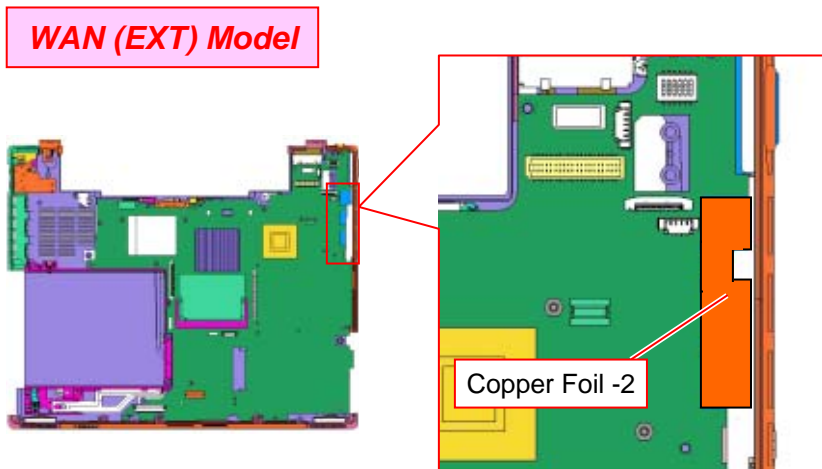

Peel off the Copper Foil-2.

5)

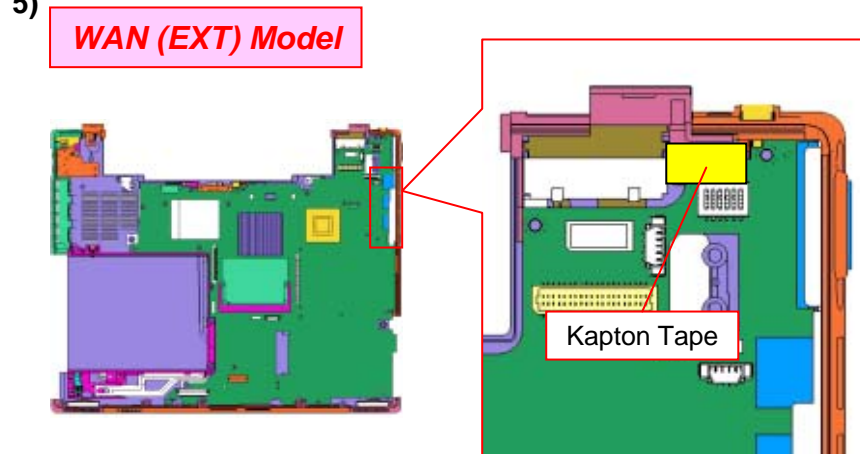

Peel off the Kapton Tape.

# Mother Board -3

6) ⚠️ [MA] 2nd Model

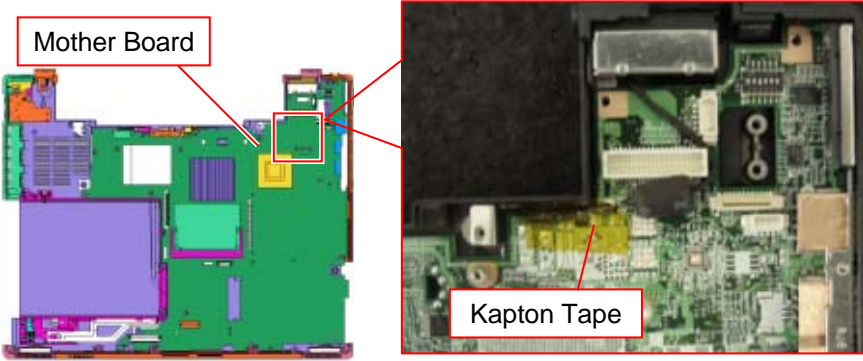

Peel off the Kapton Tape (one place).

7)

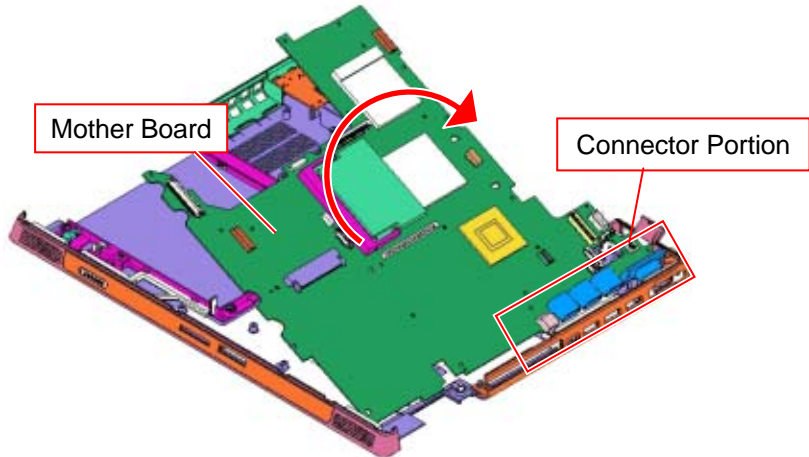

Raise the Mother Board to the right side while releasing the connector portion from the Housing.

8)

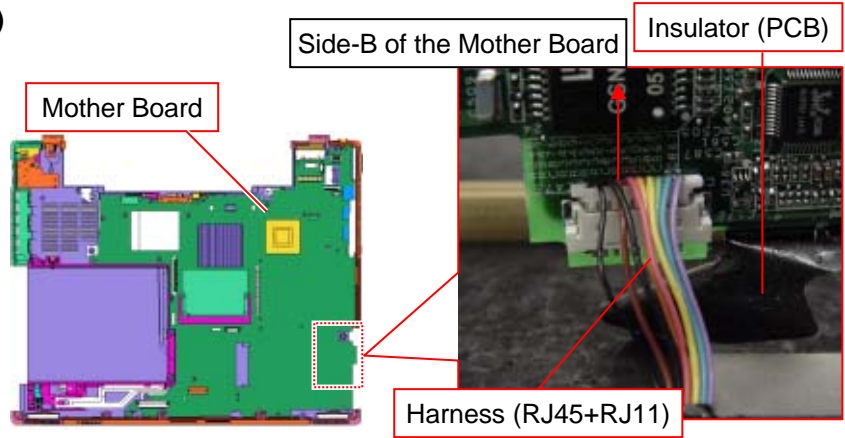

Turn over the Insulator (PCB), and disconnect the Harness (RJ45+RJ11) in the direction of the arrow.

\* Then remove the Mother Board. (1st Model) ⚠️ [MA]

9) ⚠️ [MA] 2nd Model

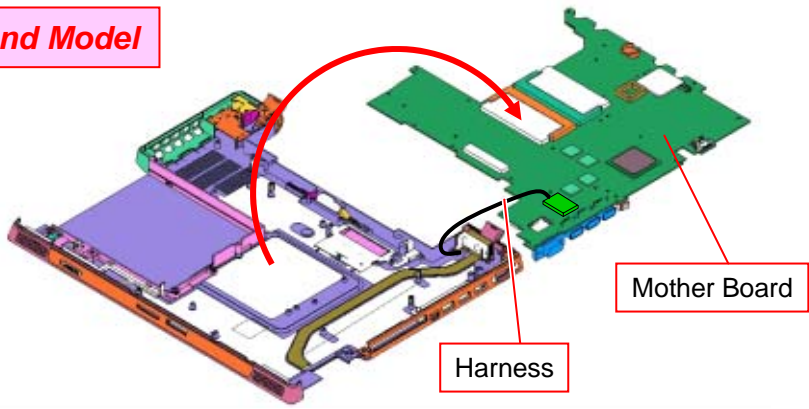

Turn over the Mother Board toward the rear.  
 \* As the Harness is connected to the rear of the Mother Board, be careful not to damage the Harness.

## Mother Board -4

10) **2nd Model**

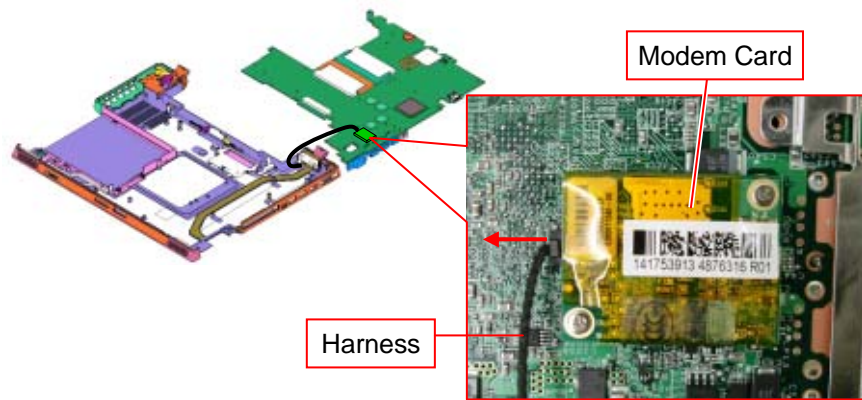

Disconnect the Harness in the direction of the arrow.  
\*Then remove the Mother Board.

# Guide Bay

1)

Screw: Red-B4  
Blue: 1st Model - B4  
⚠️ [MA] 2nd Model - B3

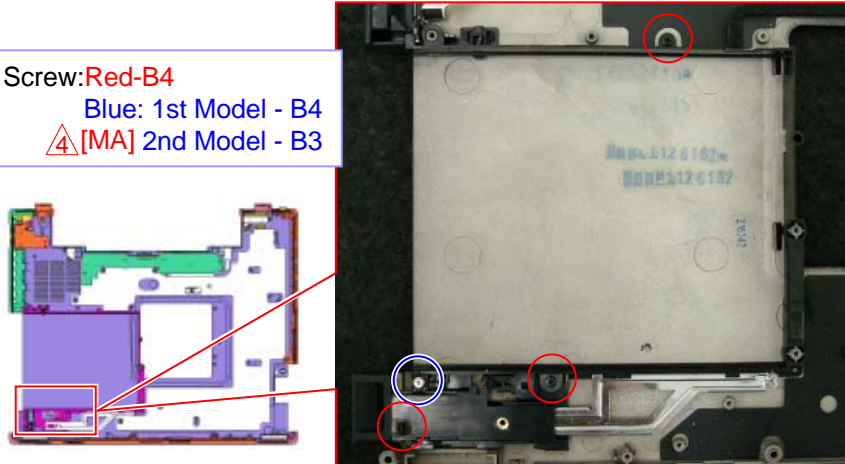

Remove the four screws.

2)

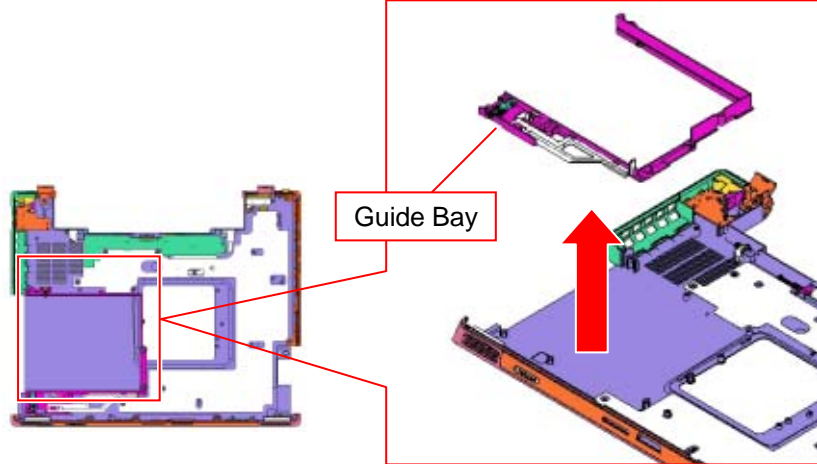

Remove the Guide Bay.

3) ⚠️ [MA]

**2nd Model**

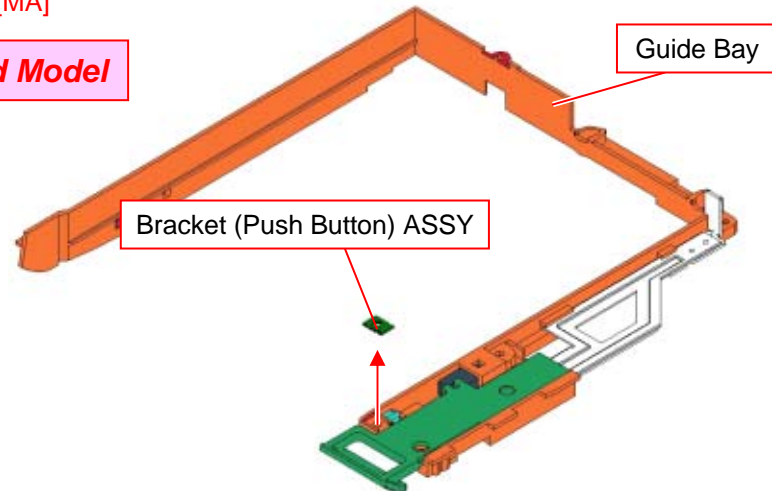

Remove the Bracket (Push Button) ASSY.



# Heat Spreader (ICH) ASSY

2nd Model

1)

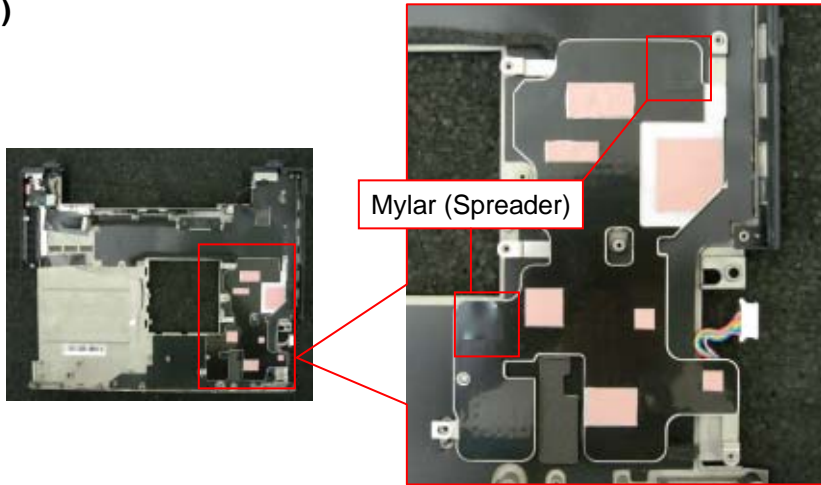

Peel off the Mylar (two places).

2)

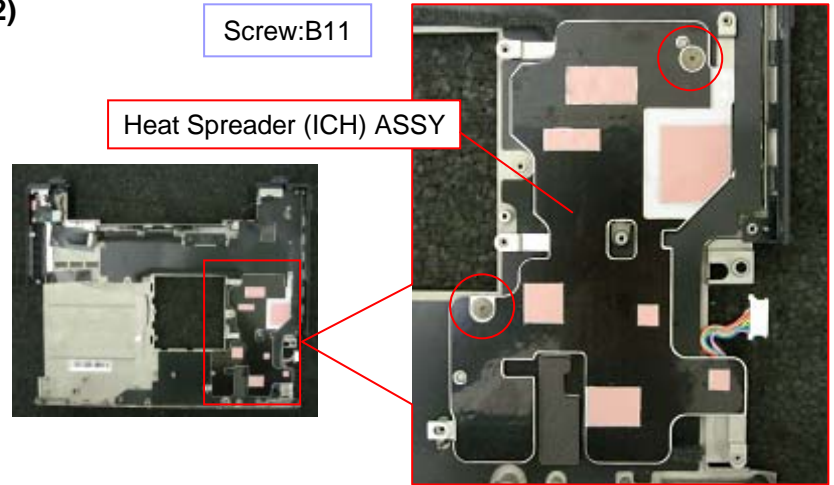

Remove the two screws, and remove the Heat Spreader (ICH) ASSY.

# Sheet, Bracket, Harness

1)

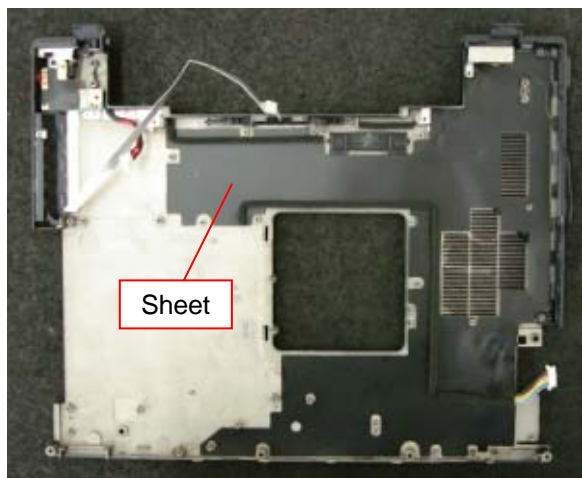

Remove the Sheet.

2)

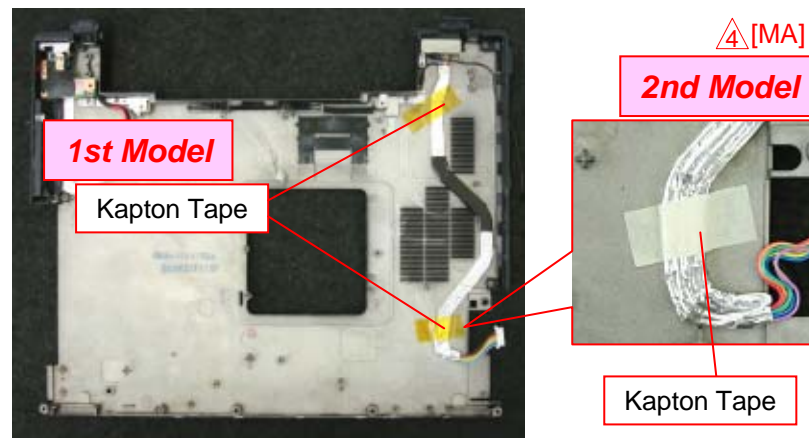

Peel off the Tape.  
 \*1st Model --- Two places  
 2nd Model --- One place

3)

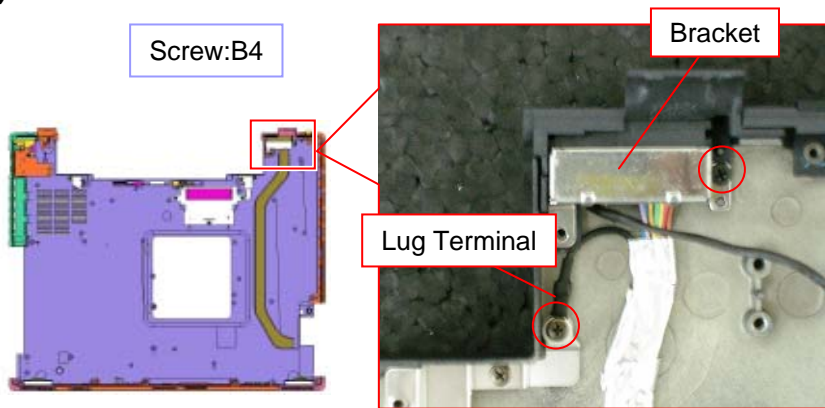

Remove the two screws and the Bracket.

4)

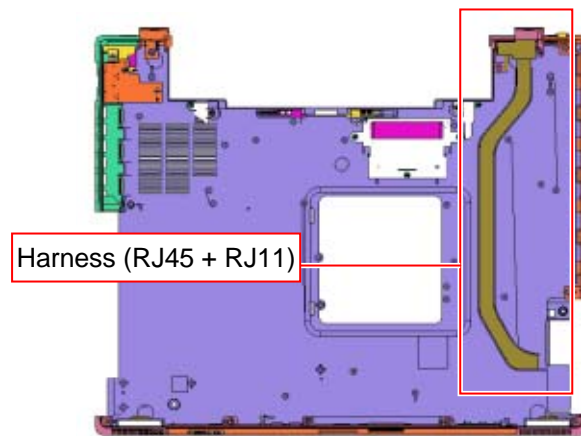

Remove the Harness (RJ45 + RJ11).

# IFX-430 Board

1)

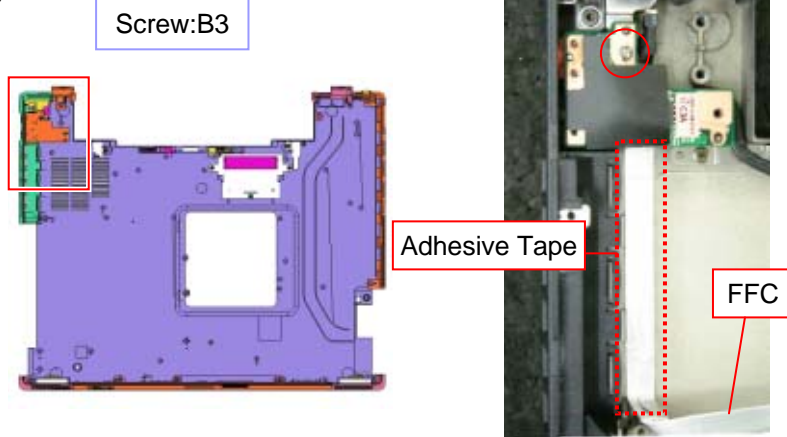

Remove the screw and peel off the FFC.

\* Adhesive Tape is attached to the rear of the FFC.

2)

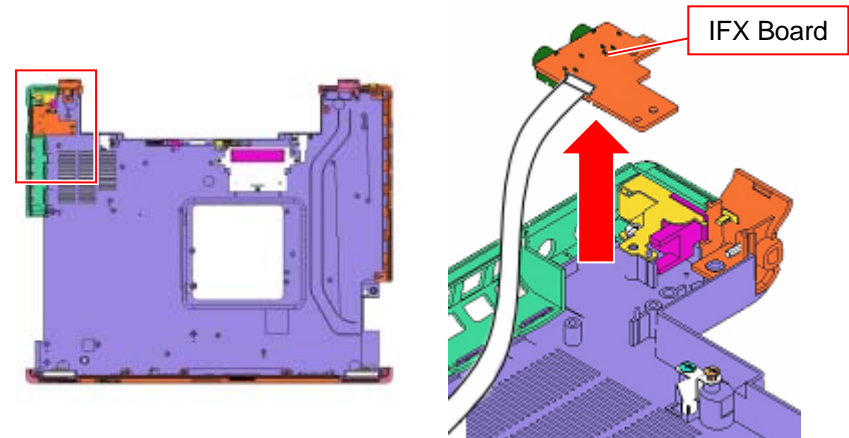

Remove the IFX Board.

3)

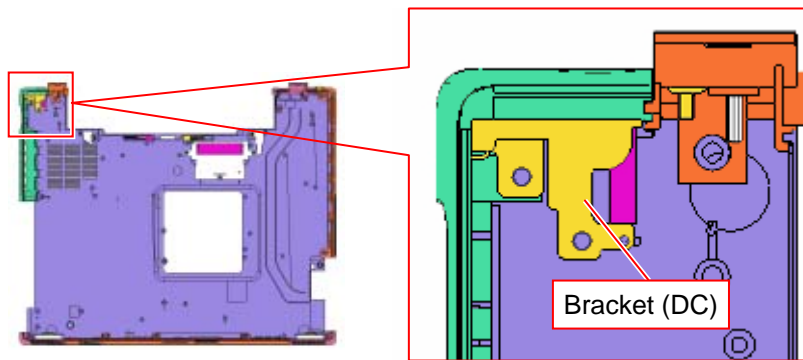

Remove the Bracket (DC).

4)

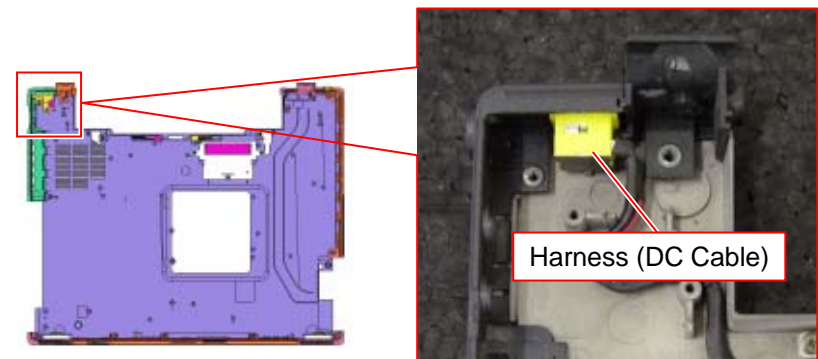

Remove the Harness (DC Cable).

# Parts of the IFX-430 Board

1)

1st Model

⚠ [MA]

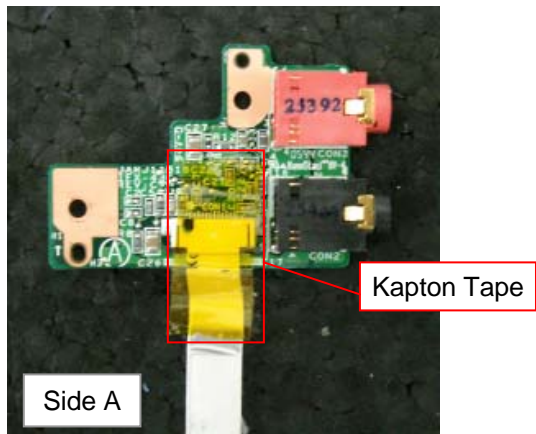

Peel off the Kapton Tape.

2)

Side A

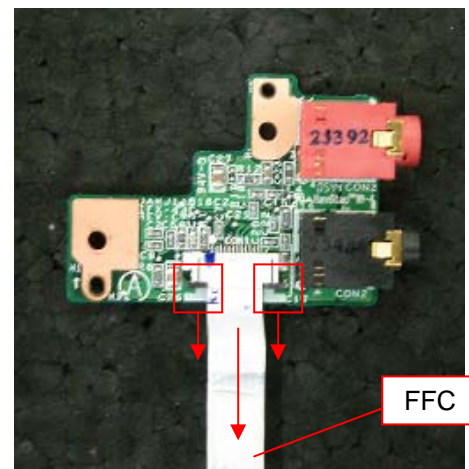

Slide the lock lever in the direction of the arrow to release the lock, and remove the FFC.

# Escutcheon (Left), Escutcheon (Right)

1)

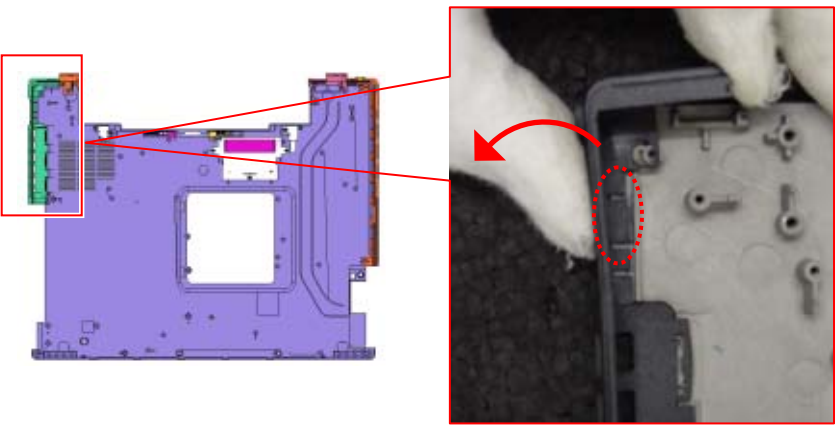

The diagram shows the laptop chassis with the left escutcheon highlighted in purple. A red box highlights the top-left corner of the escutcheon. A red arrow points to the right, indicating the direction of movement. A close-up photograph shows a hand lifting the escutcheon, with a red dashed circle highlighting a detent on the chassis that is being disengaged.

Disengage the detent (one place) while raising the Escutcheon (Left) lightly.

2)

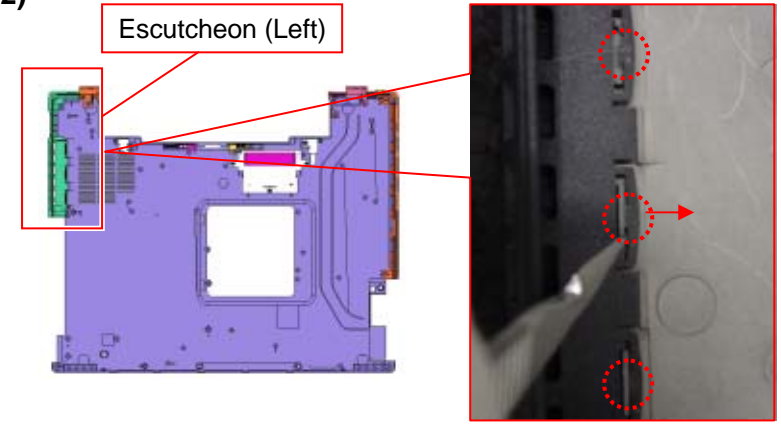

The diagram shows the laptop chassis with the left escutcheon highlighted in purple. A red box highlights the top-left corner of the escutcheon. A red arrow points to the right, indicating the direction of movement. A close-up photograph shows a hand shifting the escutcheon to the right, with three red dashed circles highlighting detents on the chassis that are being disengaged.

Disengage the detent (three places) while shifting it in the direction of the arrow with tweezers or the like.  
 \* Then remove the Escutcheon (Left).

3)

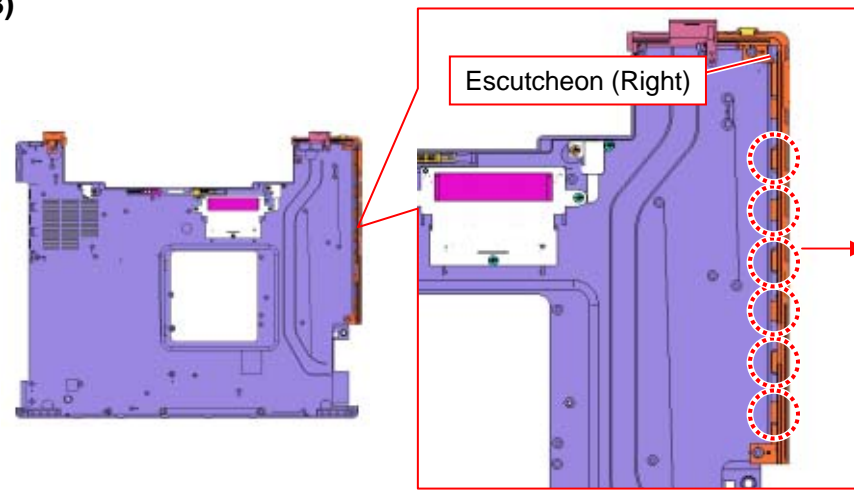

The diagram shows the laptop chassis with the right escutcheon highlighted in purple. A red box highlights the right edge of the escutcheon. A red arrow points to the right, indicating the direction of movement. A close-up photograph shows the right edge of the escutcheon with six red dashed circles highlighting detents on the chassis that are being disengaged.

Remove the Escutcheon (Right) while disengaging the detent (six places).

# Parts of the Escutcheon (Right)

1)

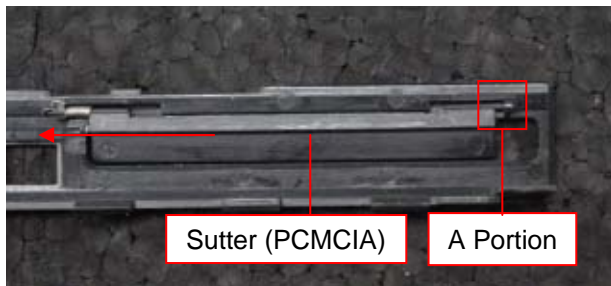

Shift the Sutter (PCMCIA) in the direction of the arrow and remove it from A portion.

2)

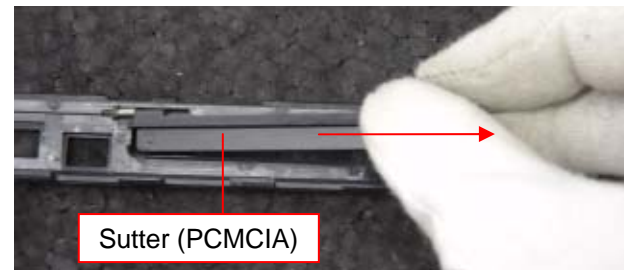

Remove the Sutter (PCMCIA).

3)

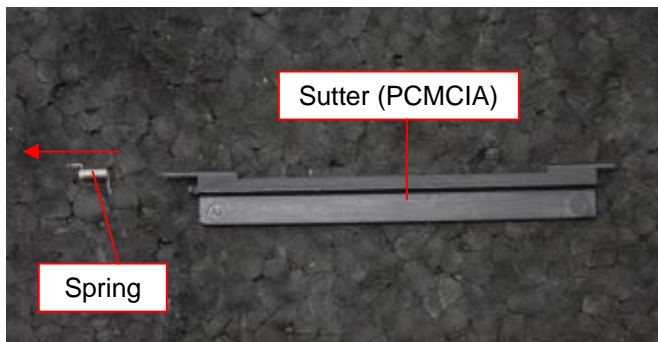

Remove the Spring.

4)

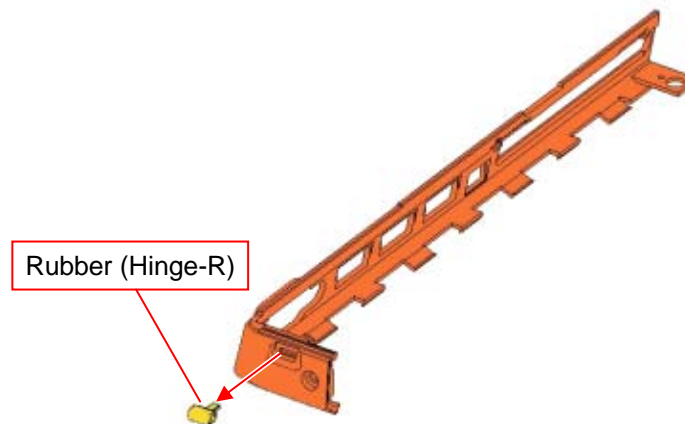

Remove the Rubber (Hinge-R).

# Parts of the Housing (Bottom) -1

1)

Door (Docking)

Detent

1

2

Raise the front side of the Door (Docking) disengaging the detent (two places) (arrow 1), and remove the Door (Docking) in the direction of the arrow 2.

2)

Screw:B5

Cover (Hook-L)

Remove the two screws and Cover (Hook-L).

3)

Screw:Red-B5  
Blue: 1st Model - B5  
⚠️[MA] 2nd Model - B11

Cover (Hook-R)

Remove the two screws and Cover (Hook-R).

4) ⚠️[MA] **2nd Model**

Screw:B4

Cover (Hinge-L)

Remove the one screw.

## Parts of the Housing (Bottom) -2

5)

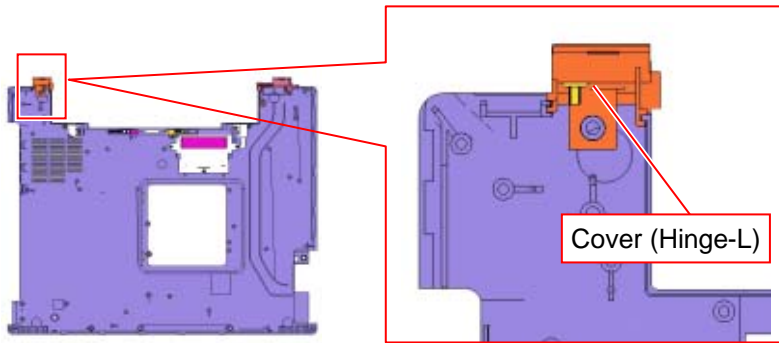

Remove the Cover (Hinge-L).

6)

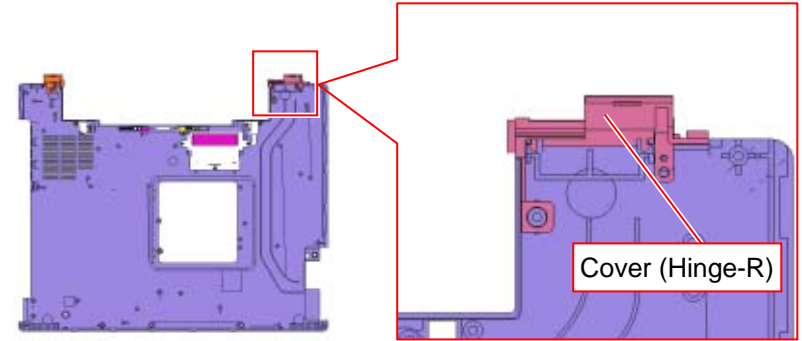

Remove the Cover (Hinge-R).

7)

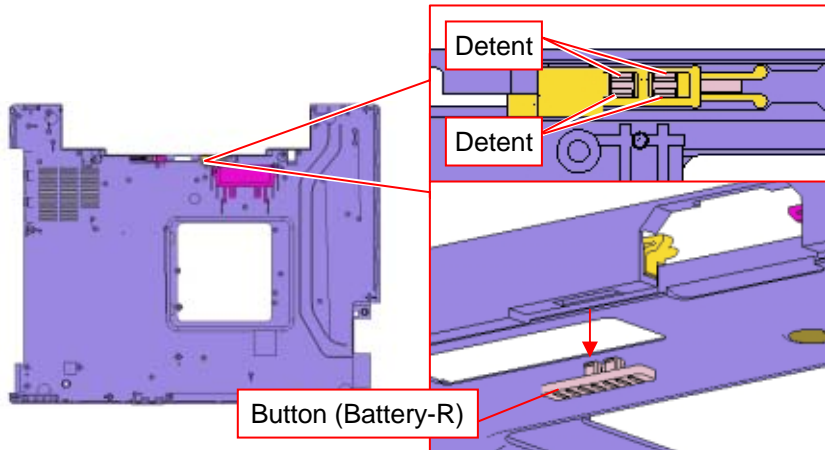

Disengage the detent (four places), and remove the Button (Battery-R).

8)

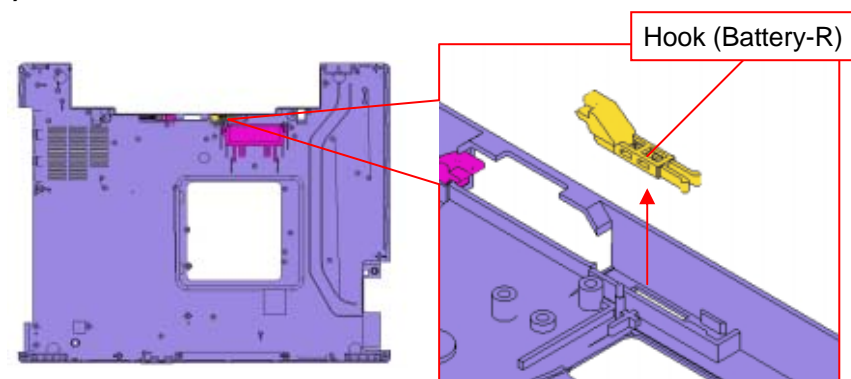

Remove the Hook (Battery-R).



# Parts of the Housing (Bottom) -3

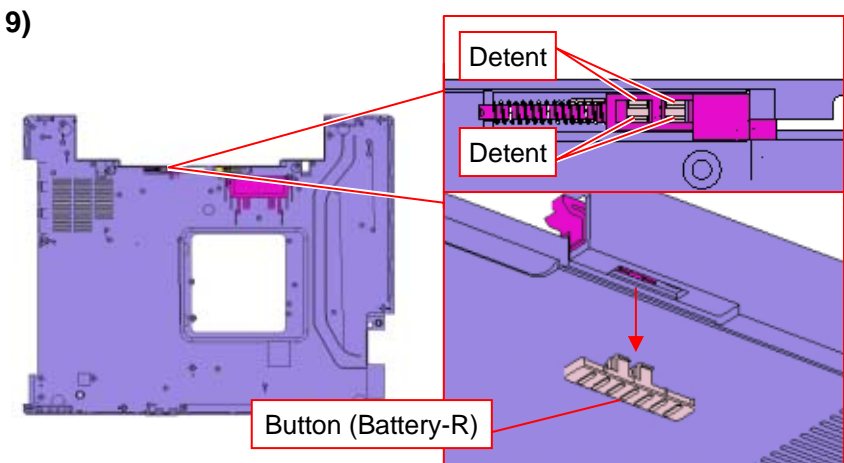

Disengage the detent (four places), and remove the Button (Battery-R).

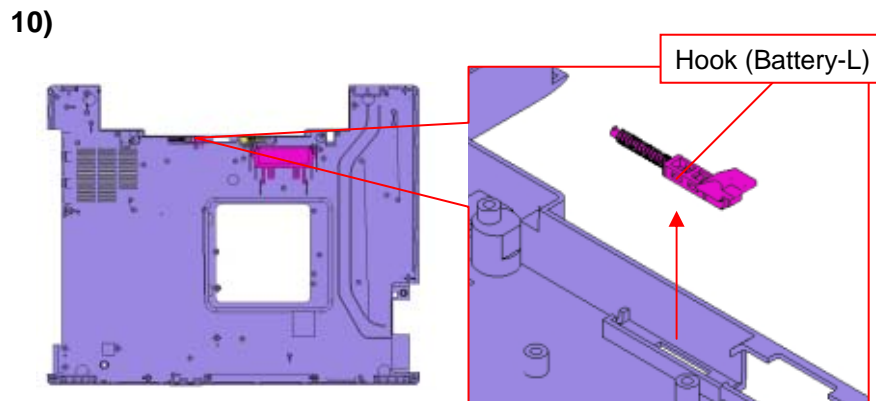

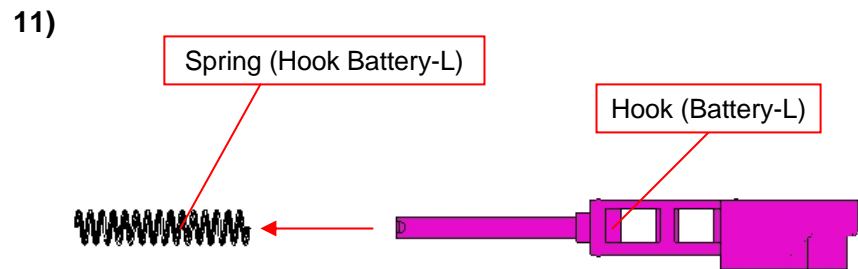

Remove the Hook (Battery-L).



Remove the Spring (Hook Battery-L).

# Update History

[**ADD**]---Addition [DEL]---Deletion [**CHG**]---Change [**COR**]---Correction [**MA**]---Model Addition

Date		Contents	Version No.
2006.08.28		[CHG] Screw (Page 17)	1.30
2006.10.20		[MA] (Page 8,9,12,13,13(a),14,15,16,16(a),17,18,19,20,20(a),21,22,25,26,27,27(a),28,28(a),29,31,34)	2.00